

Thermal Imaging Integrated Network Camera User Manual

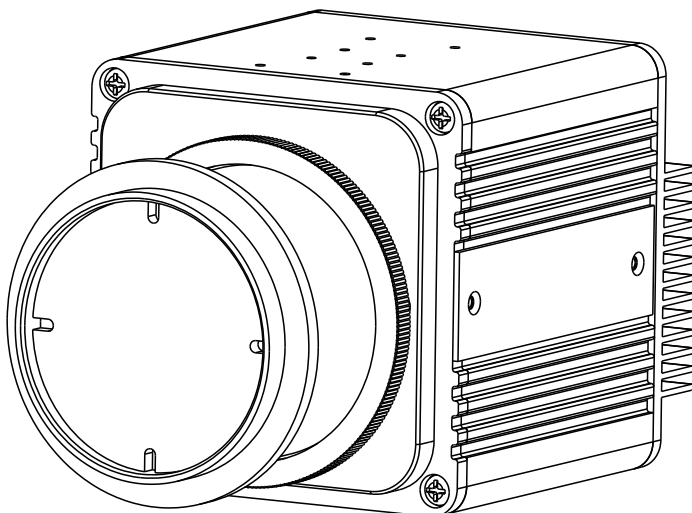

Issue

V1.1

Date

2021-07-26





Precautions

Precautions

Fully understand this document before using this device, and strictly observe rules in this document when using this device. If you install this device in public places, provide the tip "You have entered the area of electronic surveillance" in an eye-catching place. Failure to correctly use electrical products may cause fire and severe injuries. To prevent accidents, carefully read the following context:

Symbols

This document may contain the following symbols whose meanings are described accordingly.

Symbol	Description
 DANGER	It alerts you to fatal dangers which, if not avoided, may cause deaths or severe injuries.
 WARNING	It alerts you to moderate dangers which, if not avoided, may cause minor or moderate injuries.
 CAUTION	It alerts you to risks. Neglect of these risks may cause device damage, data loss, device performance deterioration, or unpredictable results.
 TIP	It provides a tip that may help you resolve problems or save time.
 NOTE	It provides additional information.

DANGER

To prevent electric shocks or other dangers, keep power plugs dry and clean.

WARNING

- Strictly observe installation requirements when installing the device. The manufacturer shall not be held responsible for device damage caused by users' non-conformance to these requirements.

- Strictly conform to local electrical safety standards and use power adapters that are marked with the LPS standard when installing and using this device. Otherwise, this device may be damaged.
- Use accessories delivered with this device. The voltage must meet input voltage requirements for this device.
- If this device is installed in places with unsteady voltage, ground this device to discharge high energy such as electrical surges in order to prevent the power supply from burning out.
- When this device is in use, ensure that no water or any liquid flows into the device. If water or liquid unexpectedly flows into the device, immediately power off the device and disconnect all cables (such as power cables and network cables) from this device.
- Do not place the thermal imaging camera and unpackaged products at a radiation source with a high intensity regardless of whether the device is in the normal power-on state, for example, the sun, laser, and electric arc welder, and place the thermal imaging camera and unpackaged products against objects with a high heat source, for example, the sun. Otherwise, the accuracy of the thermal imaging camera will be affected. In addition, the detector in the thermal imaging camera may be permanently damaged.
- If this device is installed in places where thunder and lightning frequently occur, ground the device nearby to discharge high energy such as thunder strikes in order to prevent device damage.

**CAUTION**

- Unless otherwise specified in the user manual, do not use the thermal imaging camera in an environment with the temperature lower than -10°C ($+14^{\circ}\text{F}$) or higher than 50°C ($+122^{\circ}\text{F}$). Otherwise, the images displayed by the thermal imaging camera are abnormal and the device may be damaged if working beyond the temperature range for a long period.
- During the outdoor installation, prevent the morning or evening sunlight incidence to the lens of the thermal imaging camera. The sun shade must be installed and adjusted according to the angle of the sunlight illumination.
- Avoid heavy loads, intensive shakes, and soaking to prevent damages during transportation and storage. The warranty does not cover any device damage that is caused during secondary packaging and transportation after the original packaging is taken apart.
- This device is a static sensitivity device. Improper static may damage the thermal imaging camera. ESD protection measures and reliable grounding must be well prepared for device installation and uninstallation.
- Protect this device from fall-down and intensive strikes, keep the device away from magnetic field interference, and do not install the device in places with shaking surfaces or under shocks.

- Use a soft and dry cloth to clean the device body. In case that the dirt is hard to remove, use a dry cloth dipped in a small amount of mild detergent and gently wipe the device, and then dry it again. Pay special attention to the front window of the thermal imaging camera because this is precision optics. If the front window has water spots, use a clean and soft cloth to moisten with water and wipe it. If the front window needs further cleaning, use a soft cloth dampened with isopropyl alcohol or detergent. Improper cleaning can cause damage to the device.
- The lens window of the thermal imaging camera is designed to be applicable to an outdoor environment. The window is coated with durable coating material, but may require frequent cleaning. When you found lens image degradation or excessive accumulation of pollutants, you should clear up the window in a timely manner. Exercise caution when you use this device in severe sandstorm (such as deserts) or corrosive environments (such as offshore). Improper use may cause surface coating off.
- Do not jam the ventilation opening. Follow the installation instructions provided in this document when installing the device.
- Keep the device away from heat sources such as radiators, electric heaters, or other heat equipment.
- Keep the device away from moist, dusty, extremely hot or cold places, or places with strong electric radiation.
- If the device is installed outdoors, take insect- and moisture-proof measures to avoid circuit board corrosion that can affect monitoring.
- Remove the power plug if the device is idle for a long time.
- Before unpacking, check whether the fragile sticker is damaged. If the fragile sticker is damaged, contact customer services or sales personnel. The manufacturer shall not be held responsible for any artificial damage of the fragile sticker.

Special Announcement

All complete products sold by the manufacturer are delivered along with nameplates, operation instructions, and accessories after strict inspection. The manufacturer shall not be held responsible for counterfeit products.

This manual may contain misprints, technology information that is not accurate enough, or product function and operation description that is slightly inconsistent with the actual product. The manufacturer will update this manual according to product function enhancement or changes and regularly update the software and hardware described in this manual. Update information will be added to new versions of this manual without prior notice.

This manual is only for reference and does not ensure that the information is totally consistent with the actual product. For consistency, see the actual product.

Contents

1 Product Overview	1
1.1 Thermal Imaging Principles and Advantages	1
1.2 Device Structure.....	1
1.3 Cable Connection	2
1.4 Functions and Features.....	4
2 Device Dimensions	5
3 Installation	6
3.1 Preparations.....	6
3.2 Installation Mode.....	6
3.3 Installation Procedure.....	6
4 Quick Configuration	10
4.1 Login and Logout	10
4.2 Main Page layout.....	11
4.3 Change the Password.....	13
4.4 Browse Video	14
4.4.1 Install Plugins.....	16
4.5 Setting Local Network Parameters	16
5 Thermal Setting.....	20
5.1 Temperature Parameters	20
5.2 Ambient Temperature	24
5.3 Temperature Area	25
5.4 Shield Area.....	31
5.5 Schedule Linkage	32
5.6 Bad Point Check.....	33
5.7 Version Information.....	35
6 AI Multiobject	36
6.1 Parameters of AI Multiobject	36
7 Intelligent Analysis	38
7.1 Perimeter	38
7.2 Single Virtual Fence	41
7.3 Double Virtual Fences	43
7.4 Multi Loiter	46
7.5 Converse.....	49

7.6 Personnel count	51
7.7 Enter Area.....	55
7.8 Leave Area	57
8 Parameter Setting.....	59
8.1 Sensor Setting Interface.....	59
8.2 Mode	60
8.3 Image Setting	60
8.4 Scene	62
8.5 Set Pseudocolor.....	62
8.6 FFC Control	63
8.7 Noise Reduction.....	65
8.8 Lens Control.....	66
A Troubleshooting.....	68
B Common Emission Rate.....	70

1 Product Overview

1.1 Thermal Imaging Principles and Advantages

For any object, as long as its temperature is above the absolute zero (-273.15°C), although the object does not give out light, it can radiate infrared. The infrared is also known as thermal radiation. A temperature change occurs when the infrared radiated by objects at different temperatures is absorbed by the infrared thermal detector, and thereby generating an electrical effect. An electrical signal is amplified and processed to obtain a thermal image corresponding to the distribution of heat on the surface of the object, that is, infrared thermal imaging.

- Applicable to any light environment

Traditional cameras rely on the natural or ambient light for imaging. However, the infrared thermal imaging camera can clearly image the object with the infrared heat radiation of the object without relying on any light. The infrared thermal camera is applicable to any light environment and is free from glare impact. It can clearly detect and find the target as well as identify the camouflaged and hidden target in both day and night. Therefore, it achieves real 24-hour surveillance.

- Monitoring the temperature field of the target heat distribution

The infrared thermal camera can display the temperature field of the object and change the surface temperature distribution of the object that cannot be directly seen by human eyes to the thermal image representing the surface temperature distribution of the object. By monitoring the temperature field, you can immediately identify the temperature abnormality, thereby preventing potential risks caused by the temperature, such as fire.

- Providing the cloud penetration capability

Atmosphere, dust, and clouds can absorb visible light and near infrared, but are clear to the thermal infrared for 3 to 5 microns (medium wave infrared region) and 8 to 14 microns (long wave infrared). Therefore, it is difficult for the conventional cameras to capture clear images under dense clouds, while the thermal imaging camera is able to effectively penetrate the atmosphere and clouds to capture clear images.

1.2 Device Structure

Figure 1-1 shows the rear panel of the thermal imaging box network camera. For details about the interfaces, see Table 1-1.

Figure 1-1 Appearance and interfaces of device

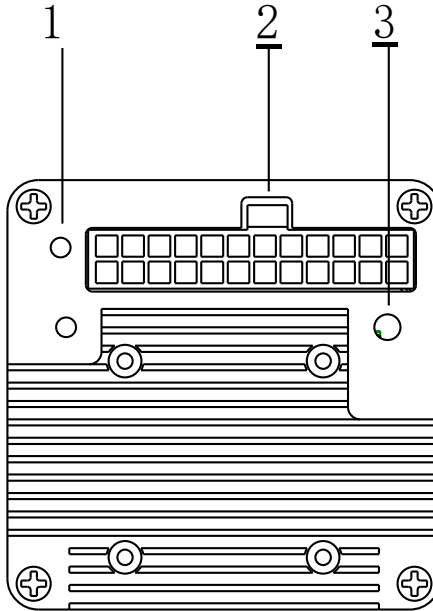

Table 1-1 Interfaces

No.	Physical Interface	Connection
1	Power indicator	Indicates the power status
2	Connector	Connector of multi-connector combination cable
3	Reset button (RESET)	The configuration resumes to the factory settings after you press the reset button for 3s. The default value of IP is 192.168.0.121.

1.3 Cable Connection

Figure 1-2 the multi-connector combination cable of the thermal imaging box network camera. For details about the multi-connector combination cable, see Table 1-2.

Figure 1-2 Multi-connector combination cable



Table 1-2 Multi-connector combination cable

ID	Functions	Connection
1	Alarm out	Connects to the external alarm out device, such as alarm light.
2	Alarm in	Inputs the alarm signal, such as doorbell.
3	Audio input	Inputs the audio signal and receives the analog audio signals from the sound pick-up device.
4	Audio output	Connects to the external audio device such as the voice box.
5	Network interface	Connects to the standard Ethernet cable.
6	Motor focus	Connects to the input interface of pan focusing signal cable.
7	Power interface	Connects to the 12 V DC power supply.

ID	Functions	Connection
8	Analog video interface	Sends analog video signals. User can connect the camera to a TV monitor through this port to view analog videos.
9	RS 485/12 V	Connects to the external pan & tilt/ Connects to a fan.

1.4 Functions and Features

- Using the uncooled infrared focal plane sensor.
- Detecting the infrared wavelength ranging from 8 um to 14 um.
- 400*300 pixels.
- High thermal sensitivity, reaching 40 Mk.
- Supporting dedicated lens for 8/15/25/35/50 mm focal distance (optional), and motor lens for 8/25/50/75 / 100 mm (optional).
- Support 17 pseudo color modes such as black hot, white hot, rainbow, iron bow and so on.
- Support the DVE image enhancement.
- Support noise reduction and mirroring.
- Support three coding algorithms, these are H. 265, H. 264 and MJPEG, high compatibility.
- In the heat setting temperature measuring points in the image or temperature area, temperature detection and display: point temperature measurement, regional temperature measuring, full screen (the highest temperature, the lowest temperature and the average temperature) temperature measurement. User can set over temperature warning and over temperature alarm.
- Output two code streams in real time, and satisfying local storage and network transmission of the video.
- 1-channel audio input and 1-channel audio output, supporting bidirectional voice talkback.
- Support the local storage, Micro SD card (the maximum capacity is 128 GB) and effectively resolving the video loss problem caused by network failure.
- Provide software and hardware watchdogs and automatic fault recovery.
- Linked heat dissipation structure of the metal enclosure.
- DC 12 V.

2 Device Dimensions

Figure 2-1 shows the dimensions of the thermal imaging box network camera.

Figure 2-1 Dimensions of 25 mm prime lens (unit: mm)

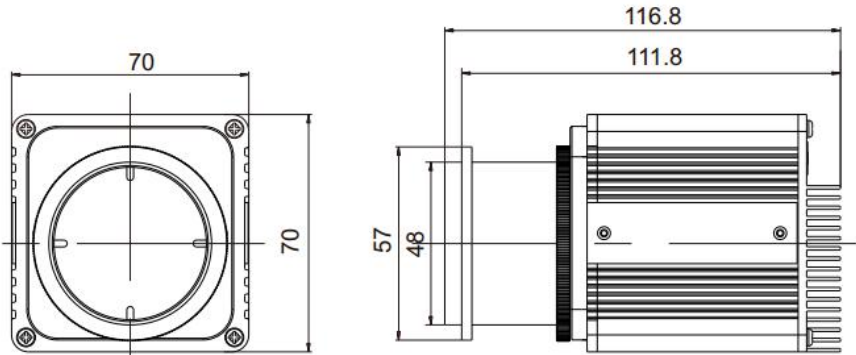

3 Installation

3.1 Preparations

User need the tools and accessories shown in Table 3-1 during the installation (you need to prepare the tools by yourself, and the accessories are in the package of the camera).

Table 3-1 Installation tools

Tools	Appearance
Phillips' screwdriver (prepare by yourself)	

3.2 Installation Mode

If the thermal imaging box camera is installed indoor, a bracket should be selected; if the thermal imaging box camera is installed outdoor, a shield should be selected.

 **NOTE**

The wall where the support is mounted must be able to withstand at least three times of the total weight of the support and the camera.

3.3 Installation Procedure

- Step 1 Remove the installation block delivered with the camera. Fix the installation block on the top or on the bottom of the camera, as shown in Figure 3-1.

Figure 3-1 Fix the installation block

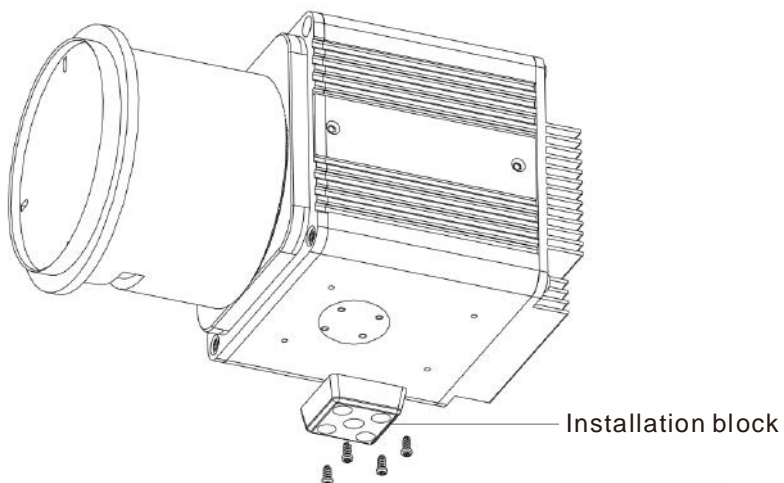

Step 2 Fix the installation block and mounting bracket, as shown in Figure 3-2.

Figure 3-2 Fixing installation block and mounting bracket

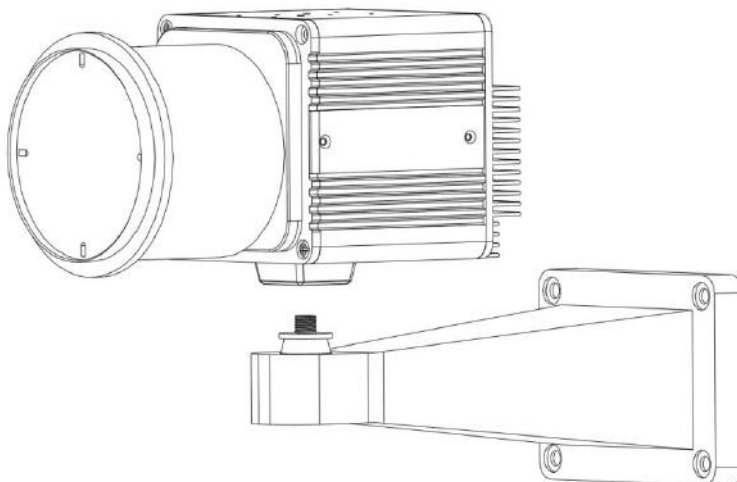

Step 3 Fix the mounting bracket on the wall, as shown in Figure 3-3.

Figure 3-3 Fix the mounting bracket

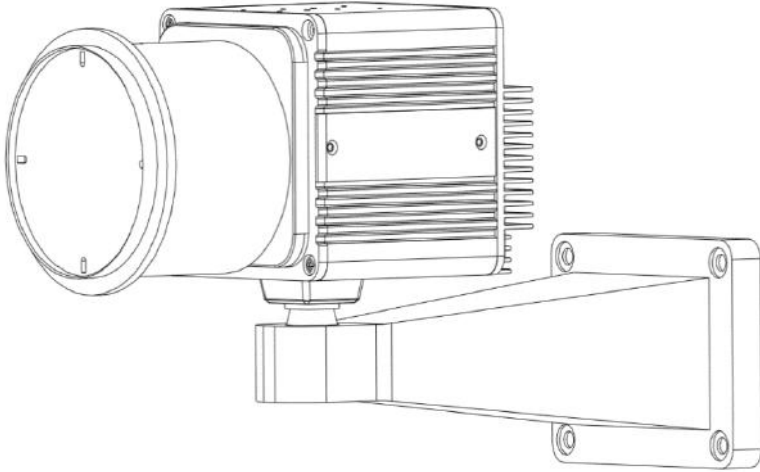

Step 4 Focusing.

(1) Focusing with focusing fixture

Grasp the handle portion of the fixture, and focus along the direction of arrows, as shown in Figure 3-4.

Figure 3-4 Focusing with focusing fixture

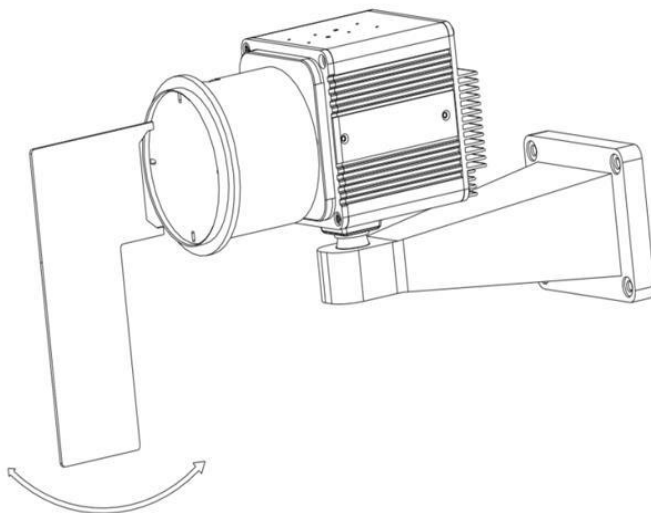

(2) Focusing with focusing screw

Insert the focusing screw into the screw hole and focus along the direction of arrows as shown in Figure 3-5.

Figure 3-5 Focusing with focusing screw

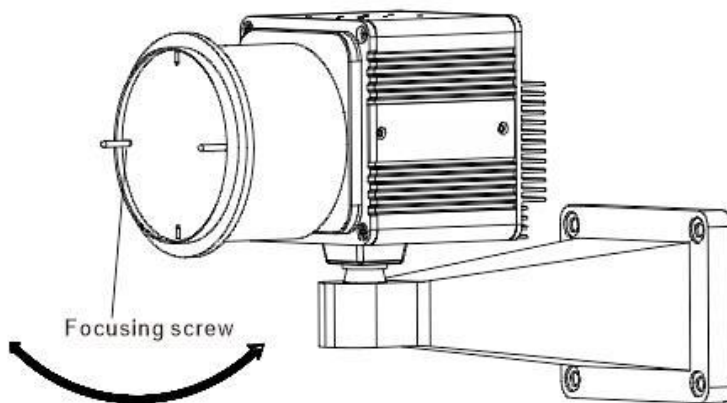

---End

4 Quick Configuration

4.1 Login and Logout



CAUTION

You must use Internet Explorer 8 or a later version to access the web management system; otherwise, some functions may be unavailable.

Login system

Step 1 Open the Internet Explorer, enter the IP address of IP camera (default value: 192.168.0.121) in the address box, and press Enter.

The login page is displayed, as shown in Figure 4-1.

Figure 4-1 Login page

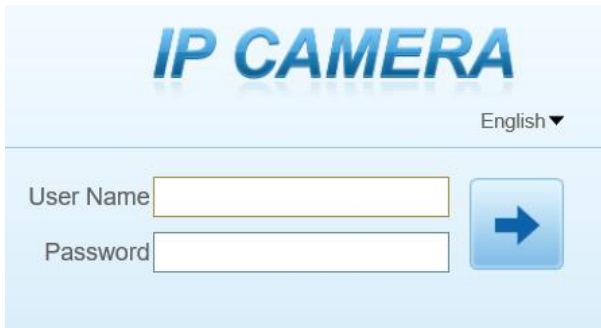

Step 2 Input the User and password.

NOTE

- The default name and password are both **admin**. Modify the password when you login the system for first time to ensure system security. After modifying password, you need to wait at least three minutes then power off to make sure modifying successfully . Or login the Web again to test the new password.
- You can change the system display language on the login page.

Step 3 Click Login arrow. The main page is displayed.

---End

logout

To logout of system, click  in the upper right corner of the main page, the login page is display after you log out of the system.

4.2 Main Page layout



On the main page, you can view real-time video, set parameter, Video parameter, Video control, and logout of the system. Figure 4-2 is shown the main page layout. Table 4-1 lists the elements on the main page layout.

Figure 4-2 Main page layout



Table 4-1 Elements on the main page

No.	Element	Description
1	Real-time video area	Real-time videos are played in this area. You can also set sensor parameters.
2	Playback	You can query the playback videos in this area.  NOTE Only when the SD card has videos that user can query the playback videos.
3	Personnel count	Count the number of people passing through the area, the statistic can be shown by line chart, histogram and list, as

No.	Element	Description
		shown in Figure 4-3.
4	Device configuration	You can choose a menu to set device parameters, including the device information, audio and video streams, alarm setting, and privacy mask function.
5	Change password	You can click  to change the password.
6	Sign Out	You can click  to return to the login page.
7	Stream	There are three streams. Choose one type from drop-down list.
8	Pause/Start	Close live video or play live video.
9	Live/Smooth	Switch image quality.
10	Audio	Open or close audio.
11	Interphone	Open or close interphone.
12	Sensor setting	Click the icon, it will access to sensor setting.
13	Snapshot	Click the icon, it will snapshot.
14	Local record	Click the icon, it will record video and save.
15	Intelligent analysis	Open the intelligent analysis, choose the stream to stream 2, click to open the intelligent analysis, it will show target information and video stream draw line after you have turned on the function in IVS settings.

NOTE





- When the device generates an alarm, the alarm icon  is displayed. You can click  to view the alarm information. When the device accepts an alarm signal, the alarm icon will display within 10s in the web management system.
- When the device encounters an exception, the fault icon  is displayed. You can click  to view the fault information.

Figure 4-3 Personnel count interface



User can choose the querying mode (year, month, day).

The data can be viewed directly, or downloaded them.

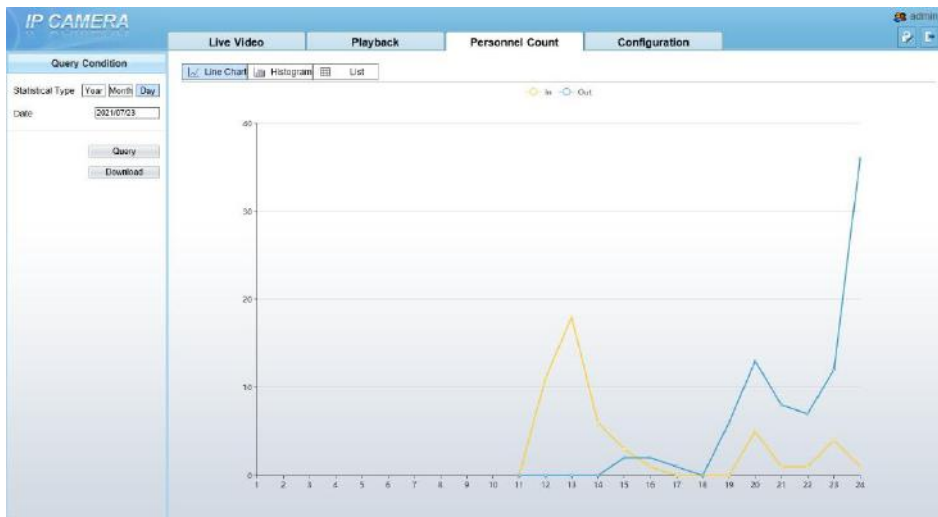
The statistic can be showed by line chart, histogram, list.

----End

4.3 Change the Password

Description

You can click  to change the password for logging to the system.

Procedure

Step 1 Click  in the upper right corner of the main page.

The **Change Password** dialog box is displayed, as shown in Figure 4-4.

Figure 4-4 Modify Password dialog box

Change Password x

Old Password

New Password

Confirm

Password Advice:

1. Advice the password length of eight characters.
2. Advice the password includes numbers, capital letters, lowercase letters and special characters.
3. Advice the password can not be the same as username.

OK Cancel

NOTE

The change password page will be displayed if you don't change the default password when you login the system for the first time. User need to wait at least three minutes after changing password, and then restart the device. The password incorrect more than 3 times, please login again after 5 minutes

Step 2 Input the old password, new password, and confirm password.

Step 3 Click **OK**.

If the message "Change password success" is displayed, the password is successfully changed. If the password fails to be changed, the cause is displayed. (For example, the new password length couldn't be less than eight.)

Step 4 Click **OK**. The login page is displayed.

---End

4.4 Browse Video

User can browse the real-time video in the web management system.

Preparation

To ensure the real-time video can be play properly, you must perform the following operation when you login to the web for the first time:

Step 1 Open the Internet Explorer. **Choose Tools > Internet options > Security > Trusted sites > Sites.**

In the display dialog box, click **Add**, as shown in Figure 4-5.

Figure 4-5 Add the a trusted site

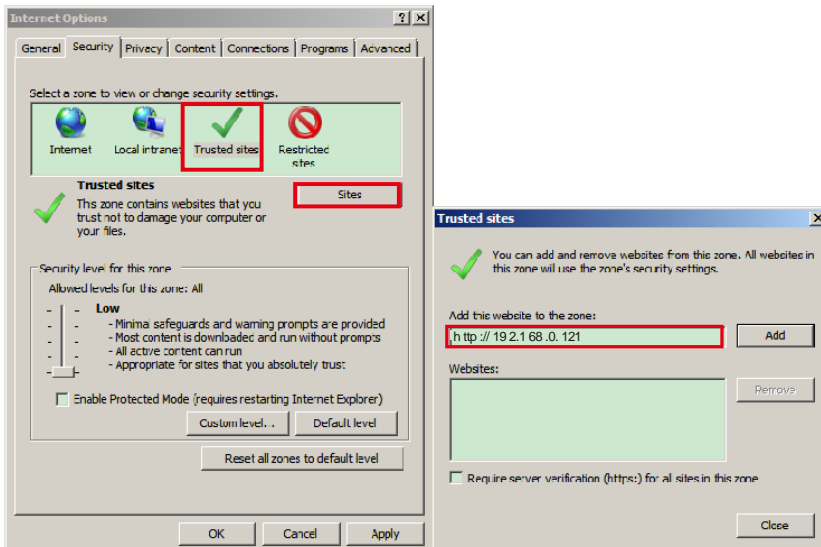

Step 2 In the Internet Explorer, choose **Tool > Internet Options > Security > Customer level**, and set Download unsigned ActiveX control and initialize and script ActiveX controls not marked as safe for scripting under ActiveX controls and plug-ins to Enable, as shown in Figure 4-6.

Figure 4-6 Configuring ActiveX control and plug-ins

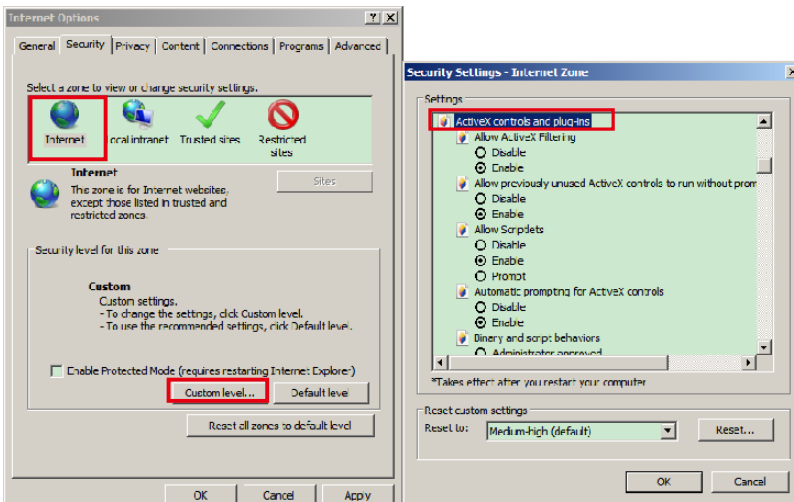

Step 3 Download and install the player control as prompted.

 **NOTE**

The login page is display when the control is loaded.

4.4.1 Install Plugins

You will be prompted with a message “Download and install the new plugin” will show as in Figure 4-7, when you login to the web management system for the first time.

Figure 4-7 Install plugin

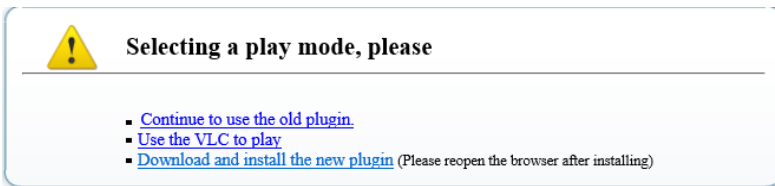

Procedure

Step 1 Click the message, download and install the plugin follow the prompts.

Step 2 During installing, user should close the browser.

Step 3 Reopen the browser after installation.

---End

4.5 Setting Local Network Parameters

Description

Local network parameters include:

- IP protocol
- IP address
- Subnet mask
- Default gateway
- Dynamic Host Configuration Protocol (DHCP)
- Preferred Domain Name System (DNS) server
- Alternate DNS server
- MTU

Procedure

Step 1 Choose **Configuration > Device >Local Network**.

The **Local Network** page is displayed, as shown in Figure 4-8.

Figure 4-8 Local Network page

 **Local Network**

Network Card ID

IP Protocol

DHCP OFF

IP Address

Subnet Mask

Default Gateway

Preferred DNS Server

Alternate DNS Server

MTU(1280-1500)

Step 2 Set the parameters according to Table 4-2.

Table 4-2 Local network parameters

Parameter	Description	Setting
IP Protocol	IPv 4 is the IP protocol that uses an address length of 32 bits. IPv 6 is the IP protocol that uses an address length of 128 bits.	[Setting method] Select a value from the drop-down list box. [Default value] IPv4
DHCP	The device automatically obtains the IP address from the DHCP server.	[Setting method] Click the option button. NOTE To query the current IP address of the device, you must query it on the platform based on the device name.
DHCP IP	IP address that the DHCP server assigned to the device.	DHCP function is enabled.

Quick Configuration

Parameter	Description	Setting
IP Address	Device IP address that can be set as required.	[Setting method] Enter a value manually. [Default value] 192.168.0.121
Subnet Mask	Subnet mask of the network adapter.	[Setting method] Enter a value manually. [Default value] 255.255.255.0
Default Gateway	This parameter must be set if the client accesses the device through a gateway.	[Setting method] Enter a value manually. [Default value] 192.168.0.1
Preferred DNS Server	IP address of a DNS server.	[Setting method] Enter a value manually. [Default value] 192.168.0.1
Alternate DNS Server	IP address of a domain server. If the preferred DNS server is faulty, the device uses the alternate DNS server to resolve domain names.	[Setting method] Enter a value manually. [Default value] 192.168.0.2
MTU	Set the maximum value of network transmission data packets.	[Setting method] Enter a value manually. NOTE The MTU value is range from 1280 to 1500, the default value is 1500, Please do not change it arbitrarily.

Step 3 Click **OK**.

- If the message "Apply success" is displayed, click **OK**. The system saves the settings. The message "Set network param's success, please login system again" is displayed. Use the new IP address to log in to the web management system.
- If the message "Invalid IP Address", "Invalid Subnet Mask", "Invalid default gateway", "Invalid primary DNS", or "Invalid space DNS" is displayed, set the parameters correctly.

**NOTE**

- If you set only the **Subnet Mask**, **Default Gateway**, **Preferred DNS Server**, and **Alternate DNS Server** parameters, you do not need to login to the system again.
- You can click **Reset** to set the parameters again if required.

---End

5 Thermal Setting

5.1 Temperature Parameters

Temperature parameters include temperature unit, ambient type, ambient temperature, cavity temperature, correctional coefficient, area temperature display mode, area temperature type, measure mode, and area alarm interval.

Operation Procedure

Step 1 Choose **Configuration > Thermal > Temperature Parameters**.

The **Temperature Parameters** page is displayed, as shown in Figure 5-1.

Figure 5-1 Temperature Parameters interface

Temperature Parameters

Open Temperature Measure	<input checked="" type="checkbox"/>
Temperature Units	Celsius
Cavity Temperature	35.81
Correction Coefficient	0.00
Area Temperature Display Mode	Low Left
Font Border	<input checked="" type="checkbox"/>
Custom Colors	<input type="checkbox"/>
Font Size	Mid
Area Temperature Type	Highest Temperature
Measure Mode	General
Display Alarm Area	<input type="checkbox"/>
Area Alarm Interval(1-1800S)	10
Area Alarm Delay(0-10Sec)	0
Temperature Range	-40.0 ~ 150.0
Prevent Over Heat	Auto
Temper Duration(5-60Sec)	60

Step 2 Set the parameters according to Table 5-1.

Table 5-1 Temperature parameters

Parameter	Description	Setting
Temperature Unit	Celsius and Fahrenheit temperature units are available.	[Setting method] Select a value from the drop-down list box. [Default value] Celsius
Cavity Temperature	The cavity temperature of camera.	N/A
Correction Coefficient	Correction coefficient is refer to the deviation of measured object temperature and actual temperature. For example: 1. The measured object temperature is 30, and actual temperature is 37, so the correction coefficient should be 7 . 2. The measured object temperature is 37, and actual temperature is 30, so the correction coefficient should be -7 .	[Setting method] Enter a value manually. [Default value] 0.00
Area Temperature Display Mode	The display position of temperature information on the live-video image.	[Setting method] Select a value from the drop-down list box. [Default value] Low left
Font Border	Enable to bold the font	[Setting method] Enable or disable [Default value] Disable
Custom Colors	Enable custom colors, user can set the font's color and size, there are nine colors chosen.	[Setting method] Select a value from the drop-down list box. [Default value] Black /Mid

Thermal Setting

Parameter	Description	Setting
Area Temperature Type	There are three types of area temperature.	[Setting method] Select a value from the drop-down list box. [Default value] Highest Temperature
Measure Mode	There are two types measure modes.	[Setting method] Select a value from the drop-down list box. [Default value] General
Display Alarm Area	N/A	[Setting method] Enable or disable [Default value] Disable
Area Alarm Interval (1-1800s)	N/A	[Setting method] Enter a value manually ranges from 1 to 1800. [Default value] 10
Area Alarm Delay(0-10Sec)	When it happens alarm, it will delay for the setting time. The default value is 0.	[Setting method] Enter a value manually ranges from 1 to 10. [Default value] 0
Temperature range	It depends the device, different devices have different modes, there are two ranges, such as -20 °C -150°C, -40 °C-150°C.	[Setting method] Select a value from the drop-down list box.
Prevent Over Heat	Open, if temperature of the testing area is too high, you can enable prevent over heat function, there are two types, manual and auto.	[Setting method] Select a value from the drop-down list box.
Temper Duration(5-60 S)	Prevent over heat' mode is auto, the control cover will block for duration time automatically if over heat.	[Setting method] Enter a value manually ranges from 5 to 60.

Parameter	Description	Setting
Control Cover	When prevent over heat mode is manual, the user should choose the action manually, such as pick up, lay down.	[Setting method] Select a value from the drop-down list box.

Figure 5-2 Advanced interface

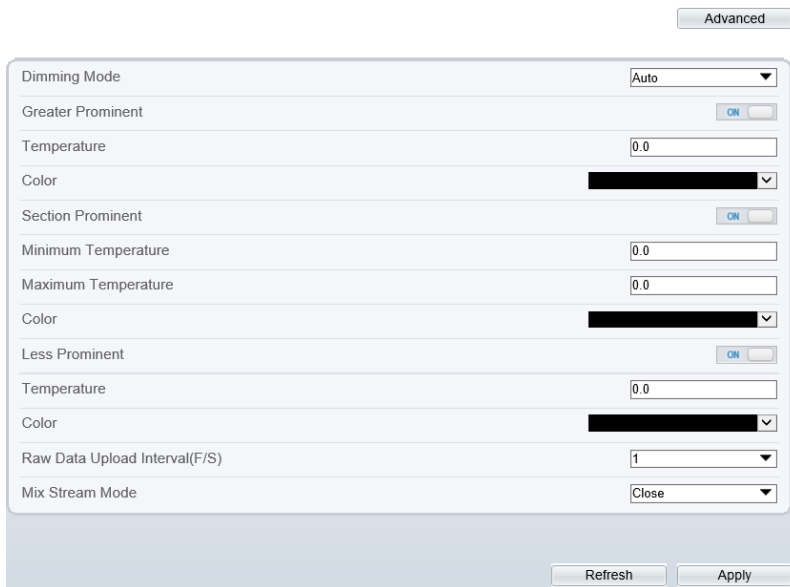

Table 5-2 Advance parameters

Parameter	Description	Setting
Dimming Mode	There are auto and manual modes. It will show on temperature item.	[Setting method] Select a value from the drop-down list box. [Default value] Auto
Greater Prominent	Enable that, the image will show the setting color if the temperature is higher than set value.	[Setting method] Enter a value manually. Choose one color to show.
Section Prominent	Enable that, the image will show the setting color if the temperature is between minimum and maximum temperature.	[Setting method] Enter a value manually. Choose one color to show.

Parameter	Description	Setting
Less Prominent	Enable that, the image will show the setting color if the temperature is lower than set value.	[Setting method] Enter a value manually. Choose one color to show.
Raw Data Upload Interval(F/S)	Interval of Upload the raw data.	[Setting method] Select a value from the drop-down list box. [Default value] 1
Mix Stream Mode	This function is used for thermal and visible lighting image to mix. There are close, mode 1, mode 2 and mode 3.	[Default value] Close

Step 3 Click **Apply**.

The message "Apply success" is displayed, the system saves the settings.

---End

5.2 Ambient Temperature

Set the ambient temperature of camera, click "Apply" to save the setting, click "Refresh" the adaptation environment temperature will be refresh based on ambient temperature.

Figure 5-3 Ambient temperature

 Ambient Temperature

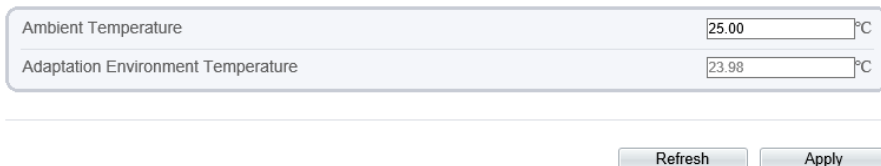

Ambient Temperature °C

Adaptation Environment Temperature °C

Table 5-3 Parameter of ambient temperature

Parameter	Description	Setting
Ambient Temperature	Environment temperature of camera.	[Setting method] Enter the temperature of ambient. [Default value] 25
Adaptation environment temperature	Set the ambient temperature, click “Apply”, click “Refresh”, the camera will get the value automatically.	---

---End

5.3 Temperature Area

Operation Procedure

Step 1 Choose **Configuration > Thermal > Temperature Area**.

The **Temperature Area** page is displayed, as shown in Figure 5-4.

Figure 5-4 Temperature area and alarm configuration

 Temperature Area And Alarm Configuration

Channel
2

Measure Mode
General

2021-03-19 23:13:43 Fri



[00] 50.3

- + 6



[*] [+] [] [] A []

Enable	ID	Name	Type	Alarm Type	Warning Value	Alarm Value	Maximum Alarm Va	Duration(1-1)
<input checked="" type="checkbox"/>	0	Area0	Rectangle	Threshold Alarm	48.00	50.00	60.00	1.00
<input type="checkbox"/>	1	Area1	Point	Threshold Alarm	48.00	50.00	60.00	1.00
<input type="checkbox"/>	2	Area2	Point	Threshold Alarm	48.00	50.00	60.00	1.00
<input type="checkbox"/>	3	Area3	Point	Threshold Alarm	48.00	50.00	60.00	1.00
<input type="checkbox"/>	4	Area4	Point	Threshold Alarm	48.00	50.00	60.00	1.00
<input type="checkbox"/>	5	Area5	Point	Threshold Alarm	48.00	50.00	60.00	1.00
<input type="checkbox"/>	5	Area5	Point	Threshold Alarm	48.00	50.00	60.00	1.00
<input type="checkbox"/>	6	Area6	Point	Threshold Alarm	48.00	50.00	60.00	1.00
<input type="checkbox"/>	7	Area7	Point	Threshold Alarm	48.00	50.00	60.00	1.00

Refresh Apply

Step 2 Set the parameters according to Table 5-4.

Table 5-4 Temperature area and alarm configuration

Parameter	Description	Setting
Channel	N/A	[Setting method] Select a value from the drop-down list box. [Default value] 1

Parameter	Description	Setting
Measure Mode	Set at temperature parameter interface.	N/A
Name	Area name of temperature area.	[Setting method] Enter a value manually.
Type	Type of temperature area. ID 0 is default rectangle area, which is full screen.	[Setting method] Select a value from the drop-down list box. [Default value] Rectangle/Point
Alarm Type	Threshold alarm, temperature difference alarm, section alarm, temperature rise alarm are available for alarm type. Section Alarm: if the temperature value is among the set temperature range, it will generate the alarm. Temperature rise alarm means it the rising temperature value is more than the set value, it will generate the alarm. It need to set the alarm schedule	[Setting method] Select a value from the drop-down list box. [Default value] Threshold alarm
Warning Value	Camera will trigger warning alarm when the object temperature reaches the warning value.	[Setting method] Enter a value manually. [Default value] 48
Alarm Value	Camera will alarm when the object temperature reaches the alarm value.	[Setting method] Enter a value manually. [Default value] 50
Maximum Alarm Value	At section alarm type, the device would not alarm when the temperature is higher than maximum alarm value.	[Setting method] Enter a value manually. [Default value] 60.00
Duration (1-10S)	Choose temperature rise alarm, set the duration, the temperature rise the value and it is kept for duration setting, the alarm is triggered successfully.	

Parameter	Description	Setting
Emission Rate	<p>The emission rate is the capability of an object to emit or absorb energy.</p> <p>The emission rate should be set only when the target is special material.</p> <p>The emission rate list refers to B Common Emission Rate</p>	<p>[Setting method] Enter a value manually. [Default value] 0.95</p>
Distance(M)	<p>The distance between camera and target.</p>	<p>[Setting method] Enter a value manually. [Default value] 15</p> <p> NOTE Enter actual distance when the distance between camera and target is less than 15m. Enter 15 when the distance between camera and target is great than or equal to 15m.</p>
Alarm	<p>Enable or disable the alarm output and linkage of area.</p>	<p>[Setting method] Tick the alarm output channel .</p>

Parameter	Description	Setting
Group ID	<p>The ID can be chosen into one of six groups, or no group. The group will be alarm following as the next rules:</p> <p>A=The highest temperature of groups (the highest temperature of N regions is the largest)</p> <p>B=Average temperature of groups (average temperature of N regions)</p> <p>WA=Warning value</p> <p>AA=Alarm value</p> <p>a. If $A-B \geq WA$, a temperature difference warning signal is generated ---> (the one with the largest difference between the N areas and the average temperature is the alarm area flashing)</p> <p>b. If $A-B \geq AA$, a temperature difference alarm signal is generated ---> (the one with the largest difference between the N areas and the average temperature is the alarm area flashing)</p> <p>c. If the warning and alarm conditions are met at the same time, the alarm signal will be generated first.</p>	<p>[Setting method]</p> <p>Select a value from the drop-down list box.</p>

Step 3 Set temperature area.

Step 1. Tick an area ID.

Step 2. Press and hold the left mouse button, and drag in the video area to draw a temperature area, as shown in Figure 5-5. Right-click to finish the area selected.

Figure 5-5 Temperature Area Setting Interface



Step 3. Click **Apply**, the message “Apply success” is displayed, the temperature area is set successfully.

NOTE

- ID 0 is the full screen, the area cannot be changed.



- : the lowest temperature of the full screen.



- : the highest temperature of the full screen.



- : the lowest temperature of the area.



- : the highest temperature of the area.

Delete a temperature area:

Step 1. Select an area ID.

Step 2. Click the temperature area and right-click.

Step 3. Remove the tick of area ID.

Step 4. Click **Apply**, the message “Apply success” is displayed, the temperature area is deleted successfully.

Step 4 Click **Apply**.

The message "Apply success" is displayed, the system saves the settings.

---End

5.4 Shield Area

Shield area is meaning that the camera will not to detect the temperature of that area.

Operation Procedure

Step 1 Choose **Configuration > Thermal > Shield Area**.

Figure 5-6 Shield Area

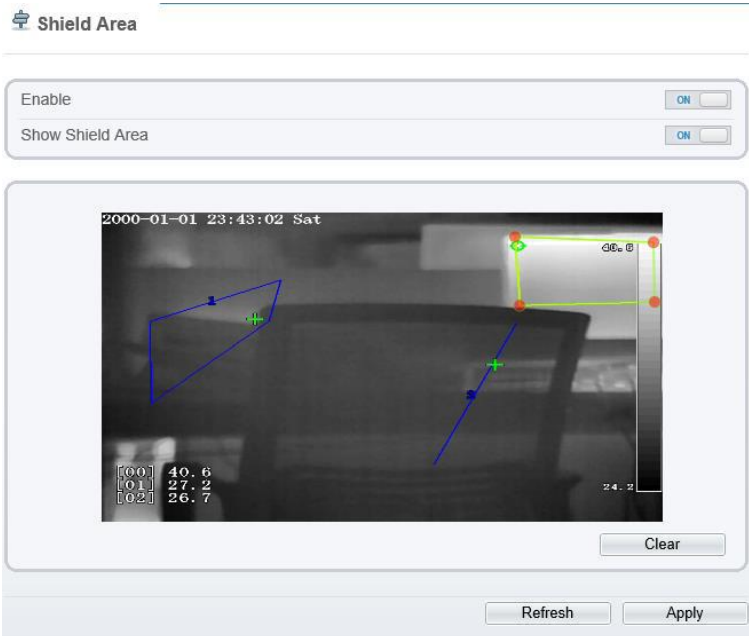

Step 2 Enable the shield area.

Step 3 Enable **Show Shield Area**, then the setting shield will show on live video.

Step 4 Click left mouse button to set area, click right mouse button to end the setting.

Step 5 Click **Clear** to clear the shield area.

---End

5.5 Schedule Linkage

Operation Procedure

Step 1 Choose **Configuration > Thermal > Schedule Linkage**.

The **Schedule Linkage** page is displayed, as shown in Figure 5-7. There are two channels alarm output. It can also enable alarm record, SMTP, FTP upload and audio detect alarm.

Figure 5-7 Schedule Linkage

Schedule Linkage

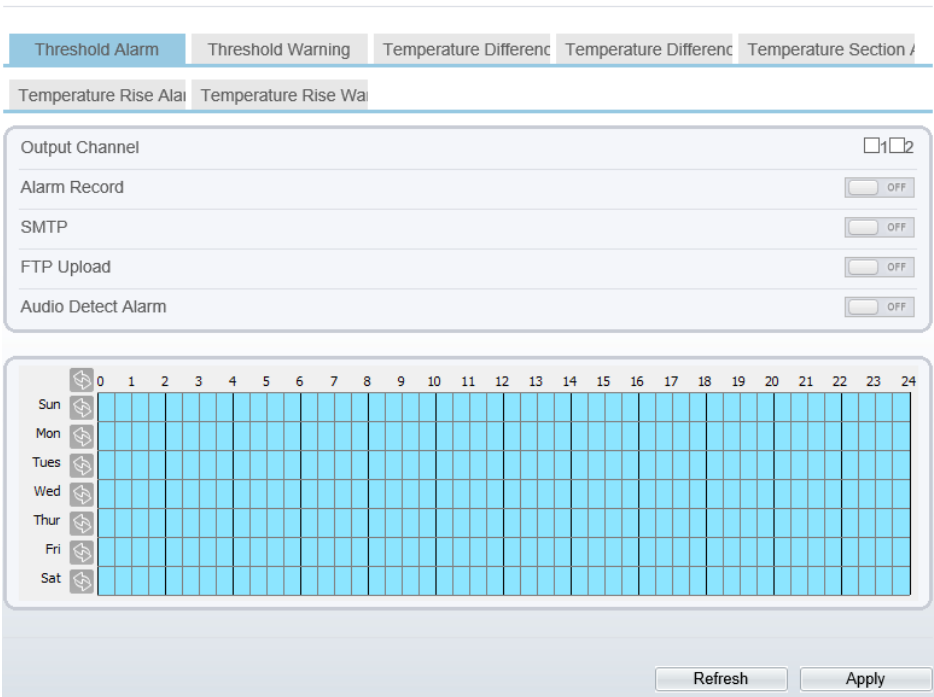

Threshold Alarm | Threshold Warning | Temperature Differenc | Temperature Differenc | Temperature Section / | Temperature Rise Alai | Temperature Rise Wa

Output Channel 1 2

Alarm Record

SMTP

FTP Upload

Audio Detect Alarm

	0	1	2	3	4	5	6	7	8	9	10	11	12	13	14	15	16	17	18	19	20	21	22	23	24
Sun																									
Mon																									
Tues																									
Wed																									
Thur																									
Fri																									
Sat																									

Step 2 Tick the output channel.

Step 3 Set schedule linkage.

Method 1: Click left mouse button to select any time point within 0:00-24:00 from Monday to Sunday as shown in Figure 5-7.

Method 2: Hold down the left mouse button, drag and release mouse to select the alarm time within 0:00-24:00 from Monday to Sunday.

 **NOTE**

- When you select time by dragging the cursor, the cursor cannot be moved out of the time area. Otherwise, no time can be selected.

Method 3: Click  in the alarm time page to select the whole day or whole week.

Deleting alarm time: Click  again or inverse selection to delete the selected alarm time.

Step 4 Click **Apply**.

The message "Apply success" is displayed, the system saves the settings.

Step 5 There are four types schedule linkage to set, like threshold alarm, threshold warning, temperature difference alarm and temperature difference warning.

---End

5.6 Bad Point Check

Operation Procedure

Step 1 Choose **Configuration > Thermal > Bad Point Check**.

The **Bad Point Check** page is displayed, as shown in Figure 5-8.

If the image is defect by detector's fault, user can test the function to recover the bad point. User should connect the manufactory at this condition to make sure to apply.

Figure 5-8 Bad Point Check

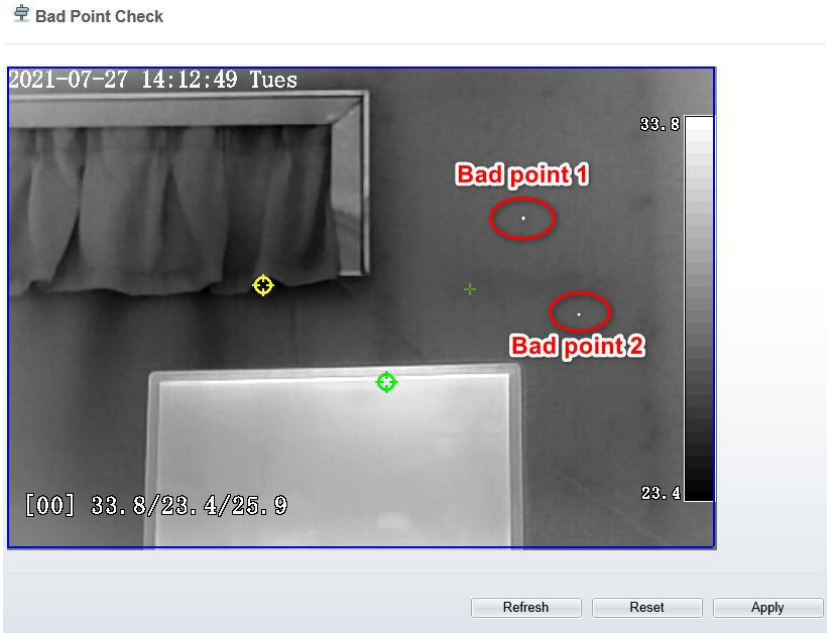

Step 2 Click the white point at image, click **Test** to recover the bad point, as shown in Figure 5-9.

Figure 5-9 Recover bad point



Step 3 Click **Apply**. The message "Apply success" is displayed, the system saves the settings.

---End

5.7 Version Information

Choose **Configuration > Thermal > Version Information**. User can view the version information as shown in Figure 5-10.

Figure 5-10 Version Information

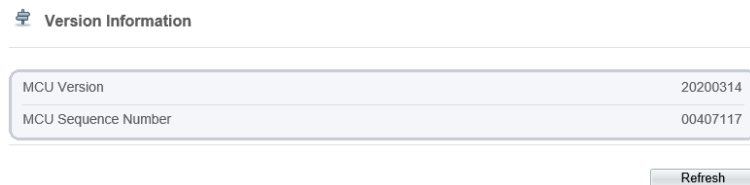

---End

6 AI Multiobject

6.1 Parameters of AI Multiobject

Figure 6-1 AI Multiobject

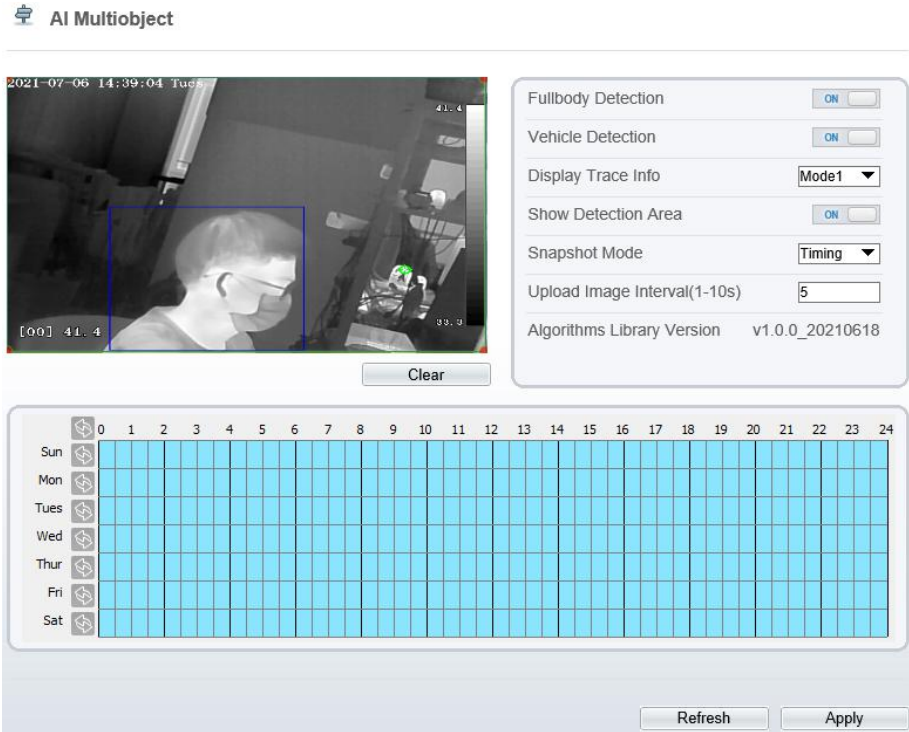

Table 6-1 Parameters of AI multiobject

Parameter	Description	How to set
Full body detection	The camera will snap the whole body when someone appear in live video.	Enable
Vehicle detection	The camera will snap the licence when the vehicle appear in live video.	Enable
Display trace info	Enable the function and a trace frame will show at live video.	Choose from drop list.

Parameter	Description	How to set
Show detection area	Enable to set a detection area, and the frame will show at live video	Enable
Snapshot mode	There are three mode can be chosen, such as timing, and optimal.	Choose from drop list.
Upload image interval(1-10 s)	At timing mode, set the interval of upload image.	Input a value ranges 1 to 10

Schedule: drag the mouse to select the time to enable alarming, or click  to choose all day or all week to enable alarming.

Figure 6-2 Schedule



--End

7 Intelligent Analysis

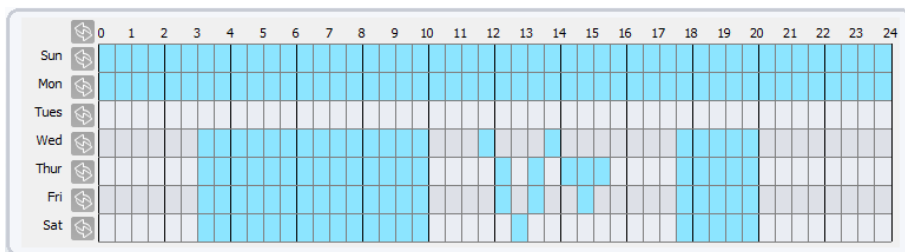
7.1 Perimeter

The perimeter function refers to that an alarm is generated when the targets of specified types (such as person, car, and both person and car) enter the deployment area.

Procedure

Step 1 Select **Intelligent Analysis > Perimeter** to access the **Perimeter** interface, as shown in Figure 7-1.

Figure 7-1 Perimeter Setting Interface

 Perimeter

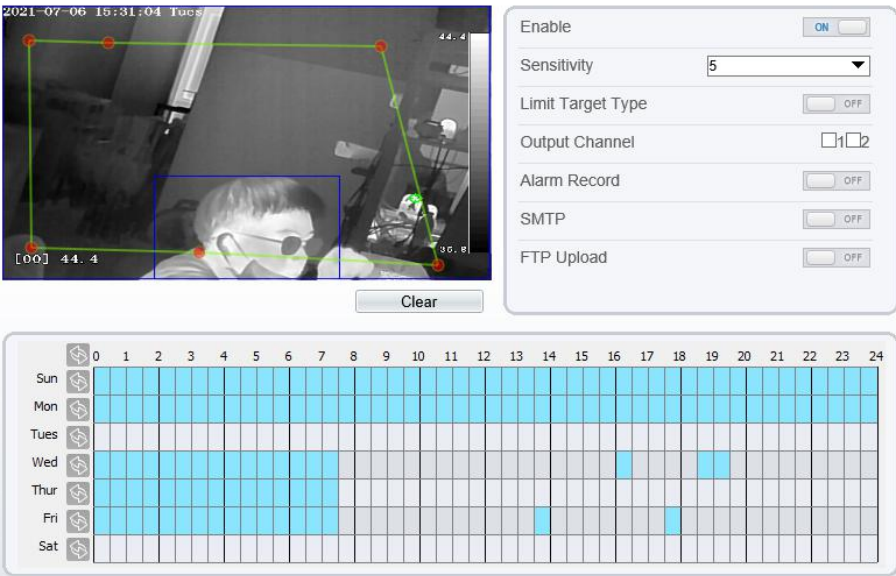

2021-07-06 16:31:04 Tues

44.4

[00] 44.4

36.8

Clear

Enable ON

Sensitivity 5

Limit Target Type OFF

Output Channel 1 2

Alarm Record OFF

SMTP OFF

FTP Upload OFF

	0	1	2	3	4	5	6	7	8	9	10	11	12	13	14	15	16	17	18	19	20	21	22	23	24
Sun	☺	☺	☺	☺	☺	☺	☺	☺	☺	☺	☺	☺	☺	☺	☺	☺	☺	☺	☺	☺	☺	☺	☺	☺	☺
Mon	☺	☺	☺	☺	☺	☺	☺	☺	☺	☺	☺	☺	☺	☺	☺	☺	☺	☺	☺	☺	☺	☺	☺	☺	☺
Tues	☺	☺	☺	☺	☺	☺	☺	☺	☺	☺	☺	☺	☺	☺	☺	☺	☺	☺	☺	☺	☺	☺	☺	☺	☺
Wed	☺	☺	☺	☺	☺	☺	☺	☺	☺	☺	☺	☺	☺	☺	☺	☺	☺	☺	☺	☺	☺	☺	☺	☺	☺
Thur	☺	☺	☺	☺	☺	☺	☺	☺	☺	☺	☺	☺	☺	☺	☺	☺	☺	☺	☺	☺	☺	☺	☺	☺	☺
Fri	☺	☺	☺	☺	☺	☺	☺	☺	☺	☺	☺	☺	☺	☺	☺	☺	☺	☺	☺	☺	☺	☺	☺	☺	☺
Sat	☺	☺	☺	☺	☺	☺	☺	☺	☺	☺	☺	☺	☺	☺	☺	☺	☺	☺	☺	☺	☺	☺	☺	☺	☺

Refresh Apply

Step 2 Set all parameters for perimeter. Table 7-1 describes the specific parameters.

Table 7-1 Perimeter Parameter Description

Parameter	Description	Setting
Enable	Enable the button to enable the alarm.	[How to set] Click Enable to enable. [Default value] OFF
Sensitivity	The sensitivity of detecting the target, when the value is high, the target can be detected easily, but the accuracy will be lower.	[How to set] Choose from the drop-down list [Default value] 5
Limit Target Type	Effective alarms are set based on target type, with options of Person or Car, person, car. When the device is used indoors, because of small space and large targets, alarms are triggered by person sometimes even if car is selected, leading to false alarms. It is recommended to set the target type to person for indoor use.	[How to set] Click to enable Limit Target Type. [Default value] OFF
Output Channel	If you check to set the Output Channel and the device is connected to an external alarm indicator, the alarm indicator signals when an alarm is triggered.	[How to set] Click to select an ID.
Alarm Record	Enable the button to enable the alarm record.	[How to set] Click to enable Alarm Record. [Default value] OFF
SMTP	Enable the button to enable SMTP sever. The parameters of SMTP can be set at Configuration > Network Service > SMTP interface.	[How to set] Click to enable SMTP. [Default value] OFF
FTP Upload	Enable the button to enable File Transfer Protocol. The parameters of FTP can be set at Configuration > Network Service > FTP interface.	[How to set] Click to enable FTP Upload. [Default value] OFF

Step 3 Set a deployment area

Move the cursor to the drawing interface and click to generate a point, move the cursor to draw a line, and then click to generate another point. This is how a line is generated. In this way, continue to draw lines to form any shape, and right-click to finish line drawing.

NOTE

- A drawn line cannot cross another one, or the line drawing fails.
- Any shape with 8 sides at most can be drawn.
- The quantity of deployment areas is not limited yet and will be described in future when a limit is applied.

Step 4 Set deployment time

Method 1: Click left mouse button to select any time point within 0:00-24:00 from Monday to Sunday as shown in Figure 7-2.

Method 2: Hold down the left mouse button, drag and release mouse to select the deployment time within 0:00-24:00 from Monday to Sunday.

NOTE

When you select time by dragging the cursor, the cursor cannot be moved out of the time area. Otherwise, no time can be selected.

Method 3: Click  in the deployment time page to select the whole day or whole week.

Deleting deployment time: Click  again or inverse selection to delete the selected deployment time.

Figure 7-2 Deployment Time Setting Interface



---End

7.2 Single Virtual Fence

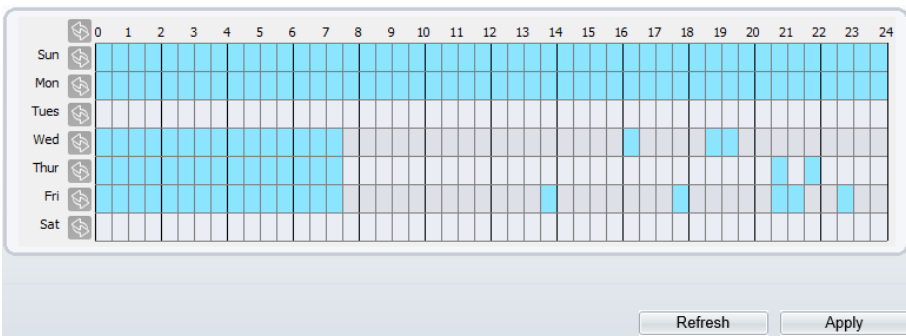
A single virtual fence is a line that is set at a concerned position within the monitored field of view and specifies the forbidden travel direction, an alarm is generated when the targets of specified types (such as person or car) cross this line.

Procedure

- Step 1 Select **Intelligent Analysis > Single Virtual Fence** to access the **Single Virtual Fence** setting interface, as shown in Figure 7-3.

Figure 7-3 Single Virtual Fence Setting Interface

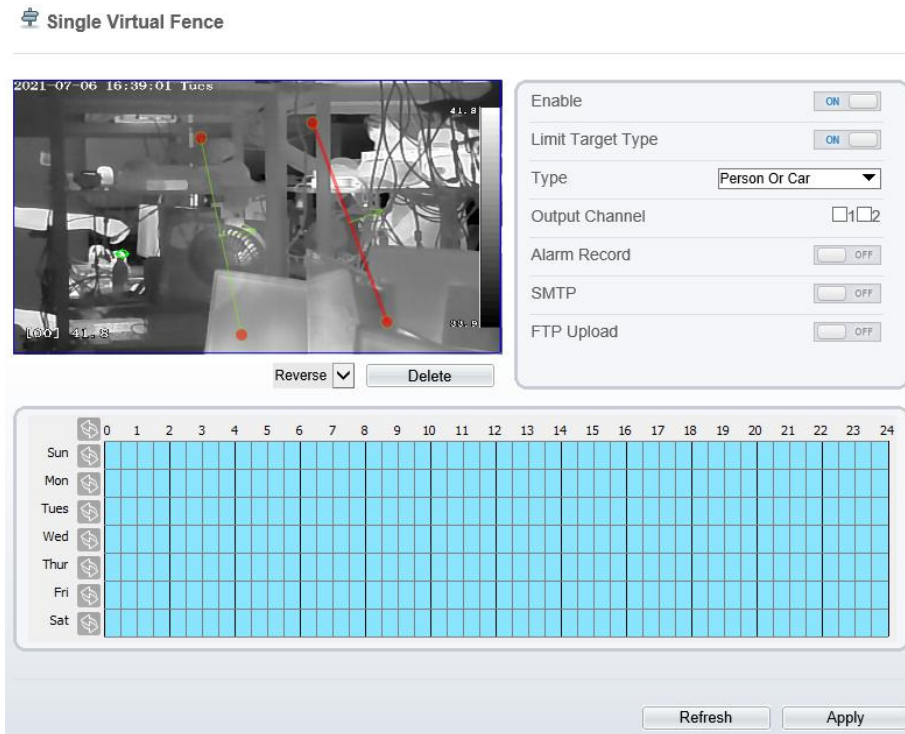

- Step 2 Set all parameters for the single virtual fence. Table 7-2 describes the specific parameters.

Table 7-2 Description of Parameters for Single Virtual Fence

Parameter	Description	Setting
Enable	Enable the button to enable the alarm.	[How to set] Click Enable to enable . [Default value] OFF
Limit Target Type	Effective alarms are set based on target type, with options of Person or Car, person, car. When the device is used indoors, because of small space and large targets, alarms are triggered by person sometimes even if car is selected, leading to false alarms. It is recommended to set the target type to person for indoor use.	[How to set] Click to enable Limit Target Type. [Default value] OFF
Output Channel	If you check to set the Output Channel and the device is connected to an external alarm indicator, the alarm indicator signals when an alarm is triggered.	[How to set] Click to select an ID.
Alarm Record	Enable the button to enable the alarm record.	[How to set] Click to enable Alarm Record. [Default value] OFF
SMTP	Enable the button to enable SMTP sever. The parameters of SMTP can be set at Configuration > Network Service > SMTP interface.	[How to set] Click to enable SMTP. [Default value] OFF
FTP Upload	Enable the button to enable File Transfer Protocol. The parameters of FTP can be set at Configuration > Network Service > FTP interface.	[How to set] Click to enable FTP. [Default value] OFF

Step 3 Set a deployment area

Drawing a line: move the cursor to the drawing interface, hold down the left mouse button, and move the cursor to draw a line. When you release the left mouse button, a single virtual fence is generated.

Setting a single virtual fence: click a line (and the trip line turns red) to select the single virtual fence and set its direction as **positive**, **reverse** or **bidirectional**, or **delete the selected** line. You can also press and hold left mouse button at the endpoint of a single virtual fence and move the mouse to modify the position and length of this single virtual fence. You can right-click to delete the single virtual fence.

**NOTE**

- A single virtual fence is not within any deployment area, therefore, when an alarm is generated, the trace always exists. Only when the target object moves out of the field of view, the trace disappears.
- Try to draw the single virtual fence in the middle, because the recognition of a target takes time after target appearance on the screen and an alarm is generated only when the object is recognized to have crossed the single virtual fence.
- The single virtual fence which detects person foot as the recognition target cannot be too short, because a short single virtual fence tends to miss targets.

Step 4 Set deployment time

Details please refer to 7.1 Step 4

---End

7.3 Double Virtual Fences

Double virtual fences refer to two lines that are set at a concerned special position within the field of view and specify the forbidden travel direction. when the targets of specified types (such as person or car) move along the set travel direction and cross these lines in a certain order (line 1 followed by line 2) in pass max time, an alarm is generated.

Procedure

Step 1 Select **Intelligent Analysis > Double Virtual Fences** to access the **Double Virtual Fences** setting interface, as shown in Figure 7-4.

Figure 7-4 Double Virtual Fences Setting Interface

Double Virtual Fences

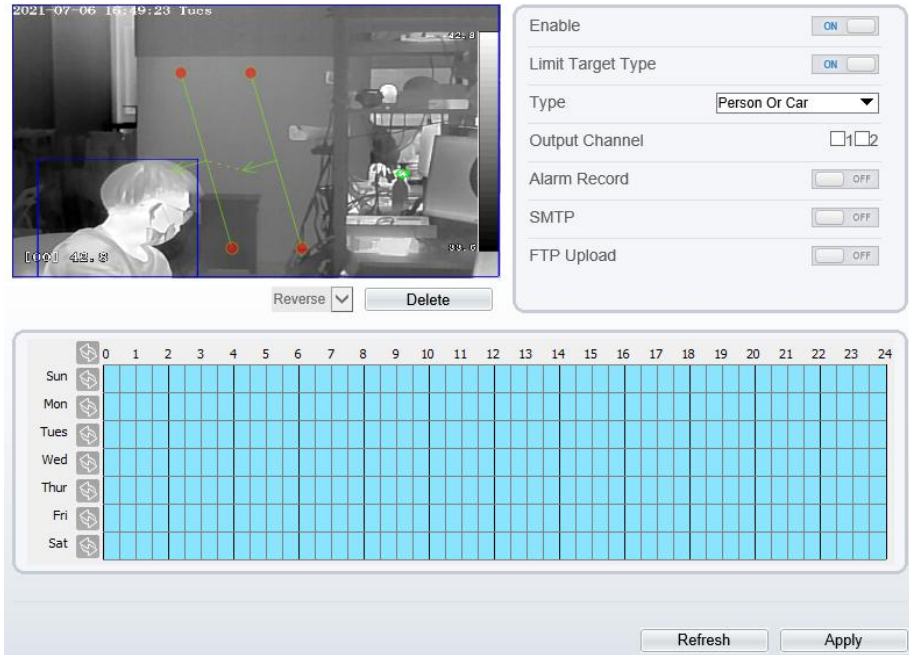

Step 2 Set all parameters for the double virtual fences. Table 7-3 describes the specific parameters.

Table 7-3 Description of Parameters for Double Virtual Fence

Parameter	Description	Setting
Enable	Enable the button to enable the alarm.	[How to set] Click to enable. [Default value] OFF
Limit Target Type	Effective alarms are set based on target type, with options of Person or Car, person, car. When the device is used indoors, because of small space and large targets, alarms are triggered by person sometimes even if car is selected, leading to false alarms. It is recommended to set the target type to person for indoor use.	[How to set] Click to enable Limit Target Type. [Default value] OFF

Parameter	Description	Setting
Output Channel	If you check to set the Output Channel and the device is connected to an external alarm indicator, the alarm indicator signals when an alarm is triggered.	[How to set] Click to select an ID.
Alarm Record	Enable the button to enable the alarm record.	[How to set] Click to enable Alarm Record. [Default value] OFF
SMTP	Enable the button to enable SMTP sever. The parameters of SMTP can be set at Configuration > Network Service > SMTP interface.	[How to set] Click to enable SMTP. [Default value] OFF
FTP Upload	Enable the button to enable File Transfer Protocol. The parameters of FTP can be set at Configuration > Network Service > FTP interface.	[How to set] Click to enable FTP. [Default value] OFF

Step 3 Set a deployment area

Drawing a line: Move the cursor to the drawing interface, hold down the left mouse button, and move the cursor to draw two lines. When you release the left mouse button, two numbered virtual fences are generated. Choose either of the double virtual fences to set the direction to Positive or Reverse.

Setting double virtual fences: Click one of the double virtual fences (and the virtual fence turns red) to select this virtual fence and set the direction to **Positive** or **Reverse**, or delete the selected line. You can also press and hold left mouse button at the endpoint of a virtual fence and move the mouse to modify the position and length of this virtual fence. You can right-click to delete the double virtual fences.

**NOTE**

- The two virtual fences are in sequential order. An alarm is generated only when a target crosses virtual fence 1 and then virtual fence 2 within the set maximum passing time.
- The double virtual fences are not within any deployment area, therefore, when an alarm is generated, the trace always exists. Only when the target object moves out of the field of view, the trace disappears.
- Try to draw double virtual fences in the middle, because the recognition of a target takes time after target appearance on the screen and an alarm is generated only when the object is recognized to have crossed the double virtual fences.
- The double virtual fences which detect person foot as the recognition target cannot be too short, because short double virtual fences tend to miss targets.

Step 4 Set deployment time

Details please refer to 7.1 Step 4.

---End

7.4 Multi Loiter

Multiple loiter allows setting the shortest loitering time for multiple targets of specified type (such as person or car) within the deployment area in the field of view. When the loitering time of the multiple targets within this area meets the set shortest loitering time, an alarm is generated.

Procedure

Step 1 Select **Intelligent Analysis > Multi Loiter** to access the **Multi Loiter** setting interface, as shown in Figure 7-5.

Figure 7-5 Multi Loiter Setting Interface

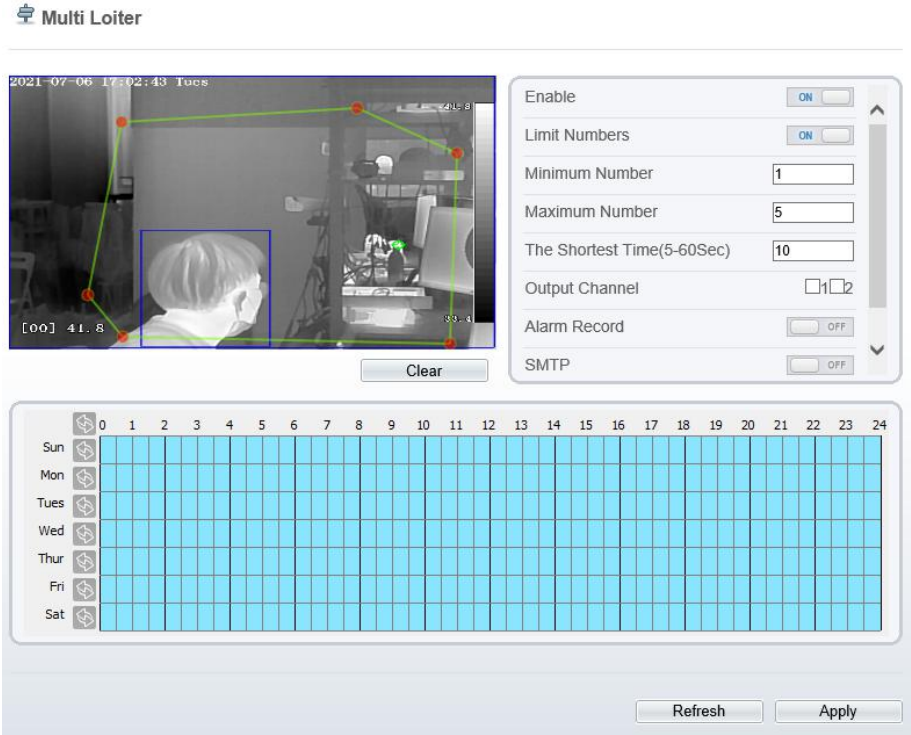

Step 2 Set all parameters for multiple loitering. Table 7-4 describes the specific parameters.

Table 7-4 Multiple Loitering Parameter Description

Parameter	Description	Setting
Enable	Enable the button to enable the alarm.	[How to set] Click Enable to enable . [Default value] OFF
Limit Target Size	The target size for triggering an effective alarm is set based on the actual target size. The minimum size is 1000 square centimeters and the maximum size is 100000 square centimeters. When setting the target size, you need to well set “Real size in scene” in advanced parameters, otherwise no alarms may be generated.	[How to set] Click to enable Limit Target Size. [Default configuration] OFF

Parameter	Description	Setting
Limit Numbers	When Limit Numbers is set to OFF, an alarm is generated no matter how many people loiter. When Limit Numbers is set to ON, if the minimum number is set to 2 and the maximum number is set to 3, an alarm is generated for 2-3 people loitering. Other settings are the same as loitering.	[How to set] Click to enable Limit Numbers.
The Shortest Time (Sec)	The time that a target object spends in loitering cannot be less than the shortest loitering time. Setting range: 5-60 seconds.	[How to set] Input a value in the area box. [Default value] 10s
Output Channel	If you check to set the Output Channel and the device is connected to an external alarm indicator, the alarm indicator signals when an alarm is triggered.	[How to set] Click to select an ID.
Alarm Record	Enable the button to enable the alarm record.	[How to set] Click to enable Alarm Record. [Default value] OFF
SMTP	Enable the button to enable SMTP sever. The parameters of SMTP can be set at Configuration > Network Service > SMTP interface.	[How to set] Click to enable SMTP. [Default value] OFF
FTP Upload	Enable the button to enable File Transfer Protocol. The parameters of FTP can be set at Configuration > Network Service > FTP interface.	[How to set] Click to enable FTP Upload. [Default value] OFF

Step 3 Set a deployment area

Move the cursor to the drawing interface and click to generate a point, move the cursor to draw a line, and then click to generate another point. This is how a line is generated. In this way, continue to draw lines to form any shape, and right-click to finish line drawing.

**NOTE**

- A drawn line cannot cross another one, or the line drawing fails.
- Any shape with 8 sides at most can be drawn .
- The quantity of deployment areas is not limited yet and will be described in future when a limit is applied.

Step 4 Set deployment time

Details please refer to 7.1 Step 4

----End

7.5 Converse

Converse allows setting the travel direction criteria for a target within an area on the video screen. When a target of specified type (such as people or car) within this area moves in the set travel direction, an alarm is generated.

Procedure

Step 1 Select **Intelligent Analysis** > **Converse** to access the **Converse** setting interface, as shown in Figure 7-6.

Figure 7-6 Converse Setting Interface

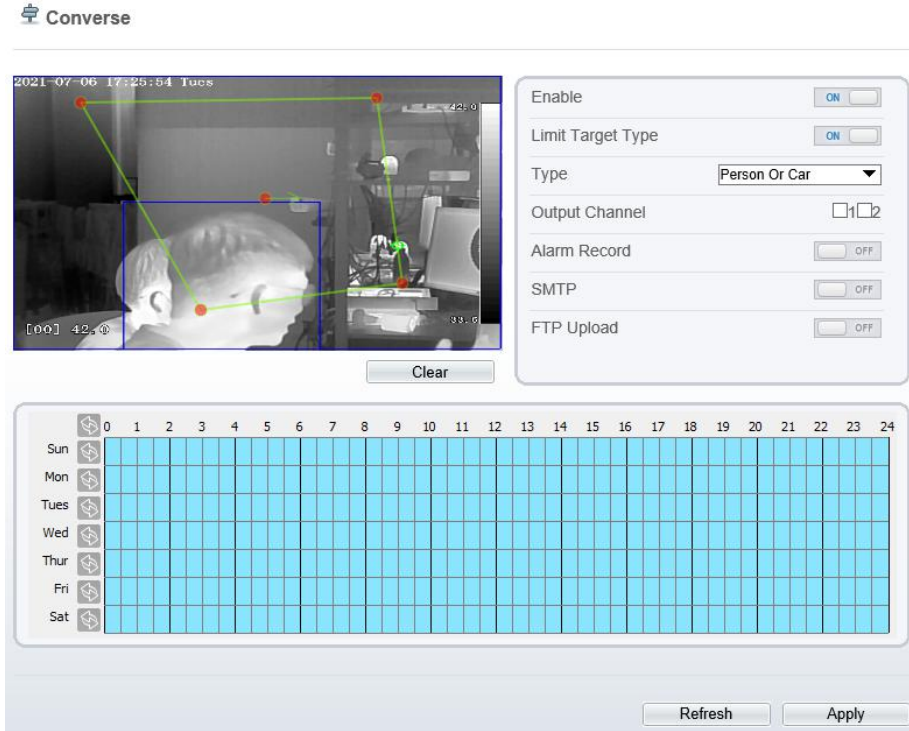

Step 2 Set all parameters for converse. Table 7-5 describes the specific parameters.

Table 7-5 Converse Parameter Description

Parameter	Description	Setting
Enable	Enable the button to enable the alarm.	[How to set] Click Enable to enable . [Default value] OFF
Limit Target Type	Effective alarms are set based on target type, with options of Person or Car, person, car. When the device is used indoors, because of small space and large targets, alarms are triggered by person sometimes even if car is selected, leading to false alarms. It is recommended to set the target type to person for indoor use.	[How to set] Click to enable Limit Target Type. [Default value] OFF

Parameter	Description	Setting
Output Channel	If you check to set the Output Channel and the device is connected to an external alarm indicator, the alarm indicator signals when an alarm is triggered.	[How to set] Click to select an ID.
Alarm Record	Enable the button to enable the alarm record.	[How to set] Click to enable Alarm Record. [Default value] OFF
SMTP	Enable the button to enable SMTP sever. The parameters of SMTP can be set at Configuration > Network Service > SMTP interface.	[How to set] Click to enable SMTP. [Default value] OFF
FTP Upload	Enable the button to enable File Transfer Protocol. The parameters of FTP can be set at Configuration > Network Service > FTP interface.	[How to set] Click to enable FTP Upload. [Default value] OFF

Step 3 Set a deployment area

Move the cursor to the drawing interface and click to generate a point, move the cursor to draw a line, and then click to generate another point. This is how a line is generated. In this way, continue to draw lines to form any shape, and right-click to finish line drawing, move the arrow in the field can set the direction of converse.

NOTE

- A drawn line cannot cross another one, or the line drawing fails.
- Any shape with 8 sides at most can be drawn .
- The quantity of deployment areas is not limited yet and will be described in future when a limit is applied.

Step 4 Set deployment time

Details please refer to 7.1 Step 4.

---End

7.6 Personnel count

ser can draw line to count the personnel at the special area.

Procedure

Step 1 Select **Intelligent Analysis > Personnel Count** to access the **Personnel Count** setting interface, as shown in Figure 7-7.

Figure 7-7 Personnel count

 **Personnel Count**

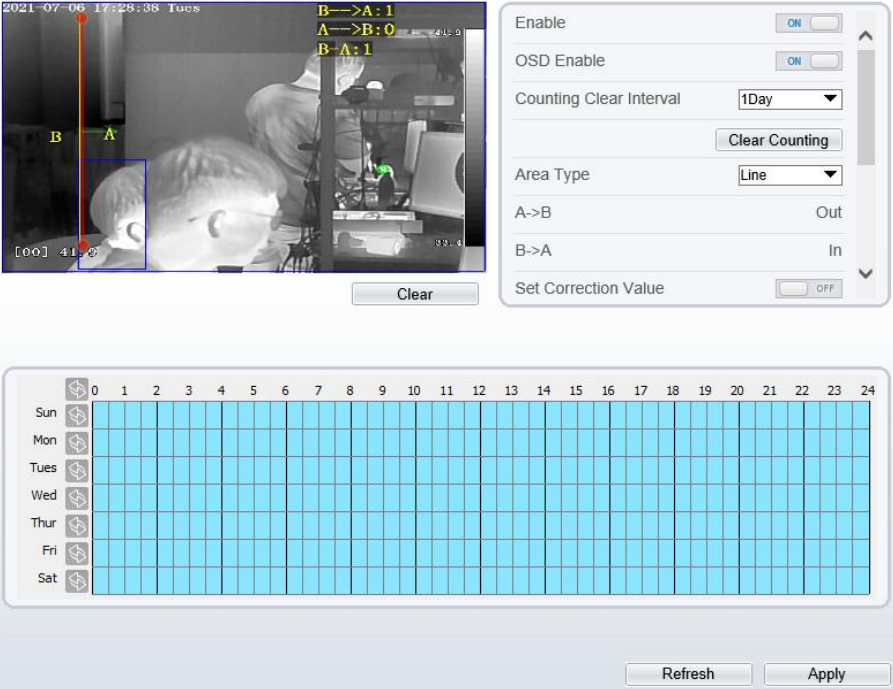

2021-07-06 17:28:38 Tues

B-->A: 1
A-->B: 0
B-A: 1

[00] 4.1

Clear

Enable ON

OSD Enable ON

Counting Clear Interval 1Day

Clear Counting

Area Type Line

A->B Out

B->A In

Set Correction Value OFF

	0	1	2	3	4	5	6	7	8	9	10	11	12	13	14	15	16	17	18	19	20	21	22	23	24
Sun																									
Mon																									
Tues																									
Wed																									
Thur																									
Fri																									
Sat																									

Refresh Apply

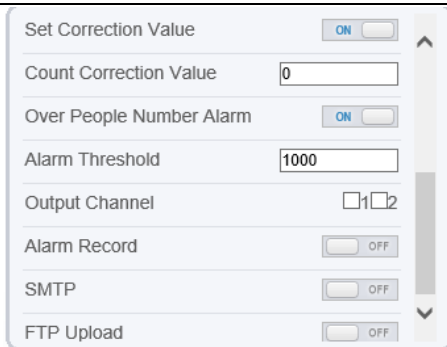

Step 2 Set all parameters for illegal parking. Table 7-6 describes the specific parameters.

Table 7-6 Description of Parameters for Personnel Count

Parameter	Description	Setting
Enable	Enable the button to enable the alarm.	[How to set] Click Enable to enable . [Default value] OFF
OSD Enable	Enable the OSD, the count data will show on live video screen.	[How to set] Click Enable to enable . [Default value] OFF
Counting Clear Interval	The camera will clear counting data at the setting interval. Click the "Clear Counting", clearing the data immediately.	[How to set] Choose from drop-down list. [Default value] 12 hours
Area Type	Draw a line on live video screen. The label of A and B indicate out and in.	[How to set] Choose from drop-down list. [Default value] Line
Set Correction Value	Enable, set the count correction value, it can be positive or negative. For example, if there are 30 people enter the area before counting, input 30 to correct. If 30 people go out the area, input -30.	[How to set] Enable /Input a value in the area box. [Default value] 0

Parameter	Description	Setting
Over People Number Alarm	Enable, if the counting number is pass the threshold, it will alarm.	[How to set] Click Enable to enable . [Default value] OFF
Alarm Threshold	the threshold of enable alarm.	[How to set] Enable /Input a value in the area box. [Default value] 1000
Output Channel	If you check to set the Output Channel and the device is connected to an external alarm indicator, the alarm indicator signals when an alarm is triggered.	[How to set] Click to select an ID.
Alarm Record	Enable the button to enable the alarm record.	[How to set] Click to enable Alarm Record. [Default value] OFF
SMTP	Enable the button to enable SMTP sever. The parameters of SMTP can be set at Configuration > Network Service > SMTP interface.	[How to set] Click to enable SMTP. [Default value] OFF
FTP Upload	Enable the button to enable File Transfer Protocol. The parameters of FTP can be set at Configuration > Network Service > FTP interface.	[How to set] Click to enable FTP Upload. [Default value] OFF

Step 3 Set a deployment area

Move the cursor to the drawing interface and click to generate a point, move the cursor to draw a line, and then click to generate another point. This is how a line is generated. In this way, continue to draw lines to form any shape, and right-click to finish line drawing.

Step 4 Set deployment time

Details please refer to 7.1 Step 4.

---End

7.7 Enter Area

Set the area, when the target enter the area, it will alarm.

Procedure

Step 1 Select **Intelligent Analysis > Enter Area** to access the **Enter Area** setting interface, as shown in Figure 7-8.

Figure 7-8 Enter area

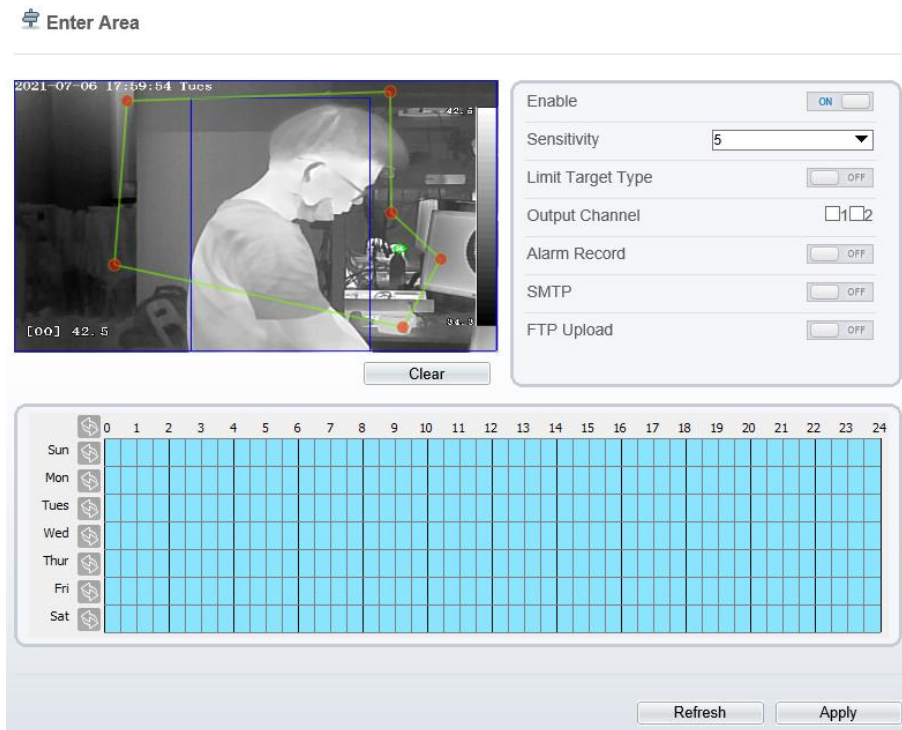

Step 2 Set all parameters for illegal parking. Table 7-7 describes the specific parameters.

Table 7-7 Description of Parameters for enter area

Parameter	Description	Setting
Enable	Enable the button to enable the enter area alarm.	[How to set] Click Enable to enable . [Default value] OFF

Parameter	Description	Setting
Sensitivity	The sensitivity of detecting the target, when the value is high, the target can be detected easily, but the accuracy will be lower.	[How to set] Choose from the drop-down list [Default value] 5
Limit Target Type	Effective alarms are set based on target type, with options of Person or Car, person, car. When the device is used indoors, because of small space and large targets, alarms are triggered by person sometimes even if car is selected, leading to false alarms. It is recommended to set the target type to person for indoor use.	[How to set] Click to enable Limit Target Type. [Default value] OFF
Output Channel	If you check to set the Output Channel and the device is connected to an external alarm indicator, the alarm indicator signals when an alarm is triggered.	[How to set] Click to select an ID.
Alarm Record	Enable the button to enable the alarm record.	[How to set] Click to enable Alarm Record. [Default value] OFF
SMTP	Enable the button to enable SMTP sever. The parameters of SMTP can be set at Configuration > Network Service > SMTP interface.	[How to set] Click to enable SMTP. [Default value] OFF
FTP Upload	Enable the button to enable File Transfer Protocol. The parameters of FTP can be set at Configuration > Network Service > FTP interface.	[How to set] Click to enable FTP Upload. [Default value] OFF

Step 3 Set a deployment area

Move the cursor to the drawing interface and click to generate a point, move the cursor to draw a line, and then click to generate another point. This is how a line is generated. In this way, continue to draw lines to form any shape, and right-click to finish line drawing.

Step 4 Set deployment time

Details please refer to 7.1 Step 4.

---End

7.8 Leave Area

When the target leave the setting area, it will be alarm.

Procedure

Step 1 Select **Intelligent Analysis > Leave Area** to access the **Leave Area** setting interface, as shown in Figure 7-9.

Figure 7-9 Leave area

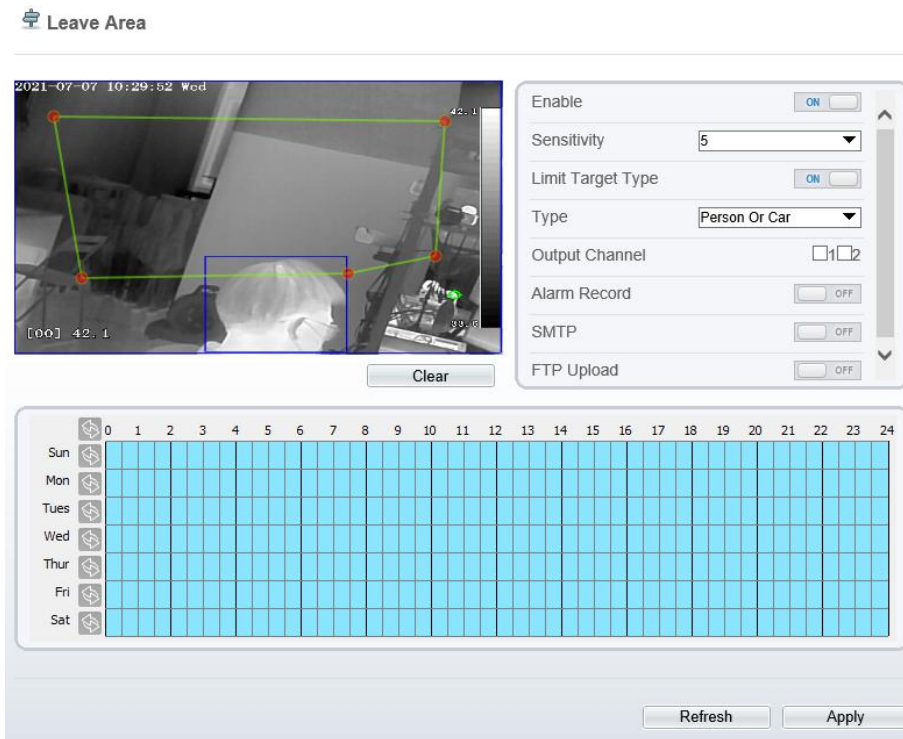

Step 2 Set all parameters for illegal parking. Table 7-8 describes the specific parameters.

Table 7-8 Description of Parameters for leave area

Parameter	Description	Setting
Enable	Enable the button to enable the enter area alarm.	[How to set] Click Enable to enable . [Default value] OFF

Parameter	Description	Setting
Sensitivity	The sensitivity of detecting the target, when the value is high, the target can be detected easily, but the accuracy will be lower.	[How to set] Choose from the drop-down list [Default value] 5
Limit Target Type	Effective alarms are set based on target type, with options of Person or Car, person, car. When the device is used indoors, because of small space and large targets, alarms are triggered by person sometimes even if car is selected, leading to false alarms. It is recommended to set the target type to person for indoor use.	[How to set] Click to enable Limit Target Type. [Default value] OFF
Output Channel	If you check to set the Output Channel and the device is connected to an external alarm indicator, the alarm indicator signals when an alarm is triggered.	[How to set] Click to select an ID.
Alarm Record	Enable the button to enable the alarm record.	[How to set] Click to enable Alarm Record. [Default value] OFF
SMTP	Enable the button to enable SMTP sever. The parameters of SMTP can be set at Configuration > Network Service > SMTP interface.	[How to set] Click to enable SMTP. [Default value] OFF
FTP Upload	Enable the button to enable File Transfer Protocol. The parameters of FTP can be set at Configuration > Network Service > FTP interface.	[How to set] Click to enable FTP Upload. [Default value] OFF

Step 3 Set a deployment area

Move the cursor to the drawing interface and click to generate a point, move the cursor to draw a line, and then click to generate another point. This is how a line is generated. In this way, continue to draw lines to form any shape, and right-click to finish line drawing.

Step 4 Set deployment time.

Details please refer to 7.1 Step 4.

---End

8 Parameter Setting

8.1 Sensor Setting Interface

Operation Procedure

Step 1 On the Internet Explorer interface or the client software interface, select and right-click the surveillance image to the set, as shown in Figure 8-1.

Figure 8-1 Sensor Setting

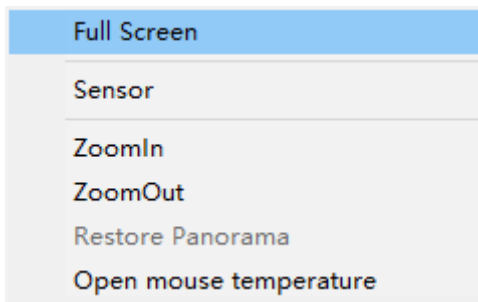

Table 8-1 Right-click setting parameters

Parameter	Description	Setting
Full screen	Click it, the live video will display in full screen	[Setting method] Click
Sensor	Set parameters of sensor, more details please refer next chapters.	[Setting method] Click
Zoom In/ Zoom Out	N/A	[Setting method] Click
Open mouse temperature	Click this, and mouse cursor display temperature of point that cursor's position.	[Setting method] Click

Step 2 Choose **Sensor**. The **Sensor Configuration** dialog box is displayed, as shown in Figure 8-2.

---End

8.2 Mode

Figure 8-2 shows the **Mode** interface.

Figure 8-2 Mode interface

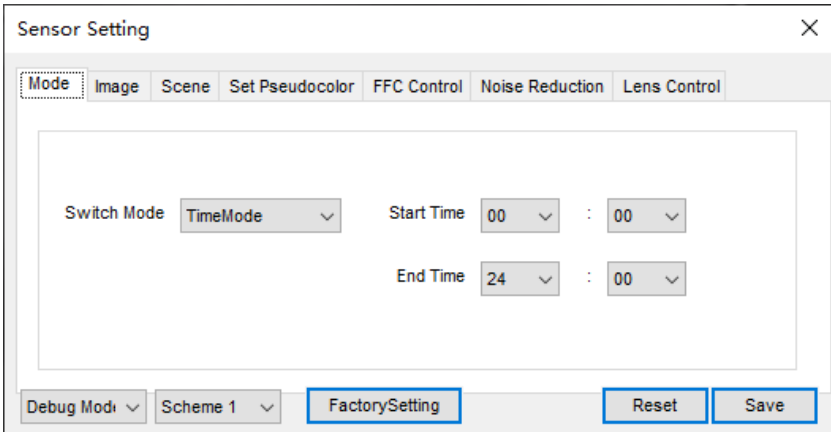

Operation Procedure

- Step 1 Click **Standard** in the lower left corner of Sensor Setting, and choose **Debug Mode**.
- Step 2 Choose the **Time Mode**.
- Step 3 Set the **Start Time**
- Step 4 Set the **End Time**
- Step 5 Click **Save**, the message "Save success" is displayed, the system saves the settings.
---End

8.3 Image Setting

Figure 8-3 shows the **Image** setting interface.

Figure 8-3 Image interface

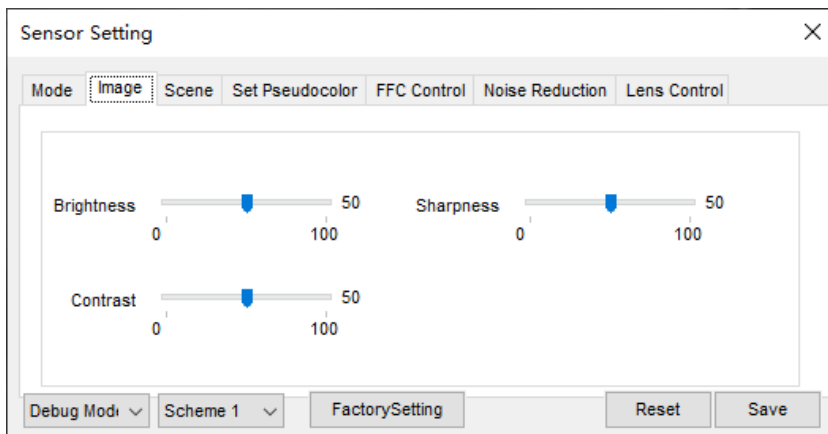

Table 8-2 lists the image setting parameters.

Table 8-2 Image setting parameters

Parameter	Description	Setting
Brightness	It indicates the total brightness of an image. As the value increases, the image becomes brighter.	[Setting method] Drag the slider. [Default value] 50
Contrast	It indicates the contrast between the bright part and the dark part of an image. As the value increases, the contrast increases.	[Setting method] Drag the slider. [Default value] 50
Sharpness	It indicates the sharpness of the image plane and the sharpness of the image edge. The shaper the image, the better detail contrast.	[Setting method] Drag the slider. [Default value] 50

---End

8.4 Scene

Figure 8-4 shows the **Scene** interface.

Figure 8-4 Scene interface

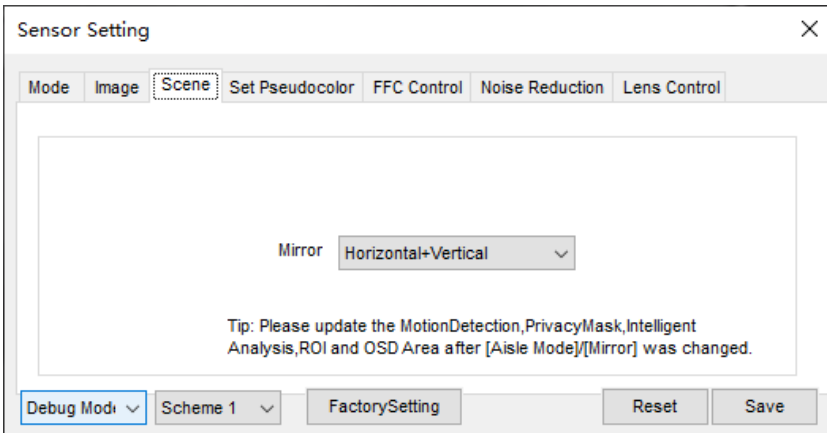

Provide the selection of image pixel locations.

Normal: the image is not flipped.

Horizontal: the image is flipped left and right.

Vertical: the image is flipped up and down.

Horizontal + Vertical: the image upside-down and reversal.

8.5 Set Pseudocolor

Figure 8-5 shows the **Set Pseudocolor** interface.

Figure 8-5 Set pseudocolor interface

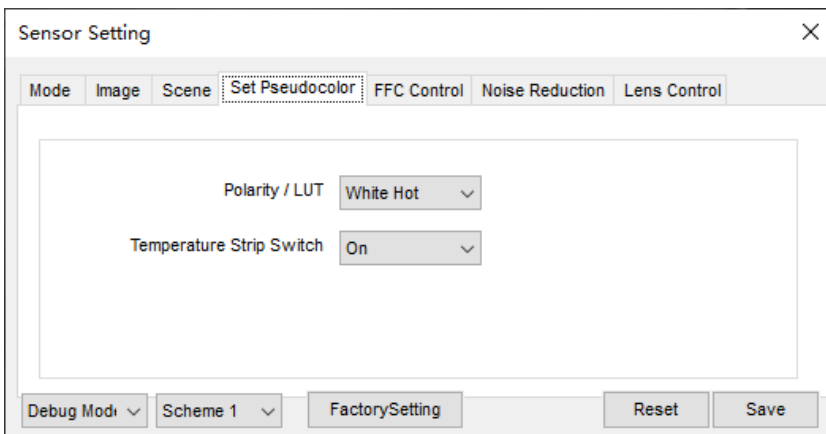

Polarity/LUT: the temperatures of the temperature fields detected by the thermal imaging camera are separately mapped to values ranging from 0 to 255 by the algorithm. In the black/white display mode, this range is converted to the grayscale tones. For example, 0 indicates completely black, and 255 indicates completely white. The temperature field of the scene is converted to images by using the grayscale display ranging from 0 to 255. Different polarity modes can be converted to different display images. The most common setting is white hot (a hotter object is displayed brighter than a colder object) or black hot (a hotter object is displayed darker than a colder object). The difference between two modes lies in that the temperatures corresponding to the darker one and the lighter one are reversed. Other modes include rainbow, ironbow, HSV, autumn, bone and so on.

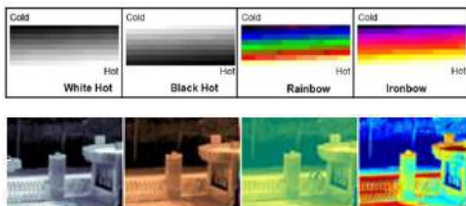

Temperature strip switch is on, the live video will show it, otherwise is no strip.

8.6 FFC Control

Figure 8-6 shows the **FFC control** interface.

Figure 8-6 FFC control interface

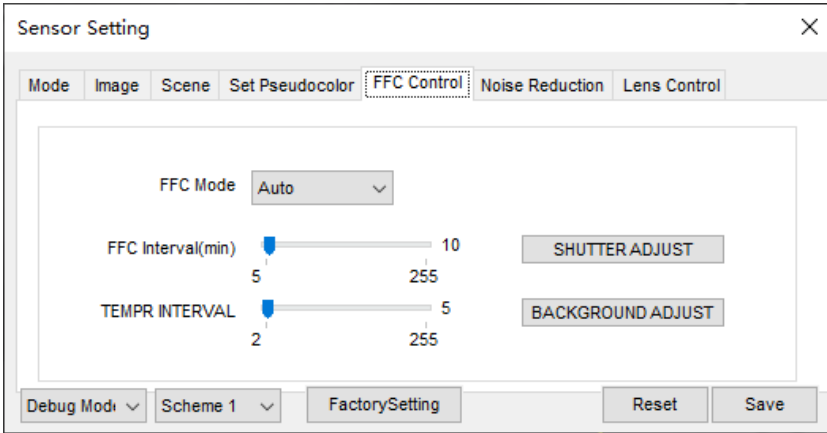

Table 8-3 lists the parameters on the FFC control interface.

Table 8-3 Parameters on the FFC control interface

Parameter	Description	Setting
FFC Mode	<p>The internal of the thermal imaging camera may comprise the mechanical action correction mechanism that can periodically improve the image quality. This component is called flat field correction (FFC). When controlling the FFC, the FFC shields the sensor array, so that each portion of the sensor can collect uniform temperature fields (flat field). By means of FFC, the camera can update the correction coefficients to output more uniform images. Throughout the FFC process, the video image is frozen for two seconds and a static-frame image is displayed. After the FFC is complete, the image is automatically recovered. Repeated FFC operations can prevent the grainy and image degradation problems. The FFC is especially important when the temperature of the camera changes. For example, after the camera is powered on or the ambient temperature is changed, you should immediately perform the FFC.</p> <p>Auto: In the Automatic FFC mode, the camera performs FFC whenever its temperature changes by a specified amount or at the end of a specified period of time (whichever comes first). When this mode is selected, the FFC interval (minutes) ranges from 5 to 255 minutes. The temperature change of the camera is based on the temperatures</p>	<p>[How to set] Select from the drop-down list box. [Default value] Auto</p>

Parameter	Description	Setting
	<p>collected by the internal temperature probe. The temperature of the camera sharply changes when the camera is powered on. The FFC is relatively frequent, which is normal.</p> <p>Manual: In the manual FFC mode, the camera does not automatically perform the FFC based on the temperature change or the specified period. You can press the Do FFC button to select the manual FFC mode. When you feel that the image is obviously degraded but the automatic FFC is not performed, you can use the manual FFC function to check whether the image quality can be improved.</p>	
FFC Interval (min)	In the automatic FFC mode, the FFC interval ranges from 5 to 255 minutes.	[How to set] Drag the slider. [Default value] 5
Temper Interval	In the automatic FFC mode, the FFC interval ranges from 5 to 25.5 centigrade.	[How to set] Drag the slider. [Default value] 5
Shutter Adjust	Click the icon to adjust exposure immediately.	N/A
Background Adjust	Click the icon and cover the camera with something to adjust image. Remove the thing to finish adjustment.	N/A

---End

8.7 Noise Reduction

Figure 8-7 shows the **Noise Reduction** interface.

Figure 8-7 Noise reduction interface

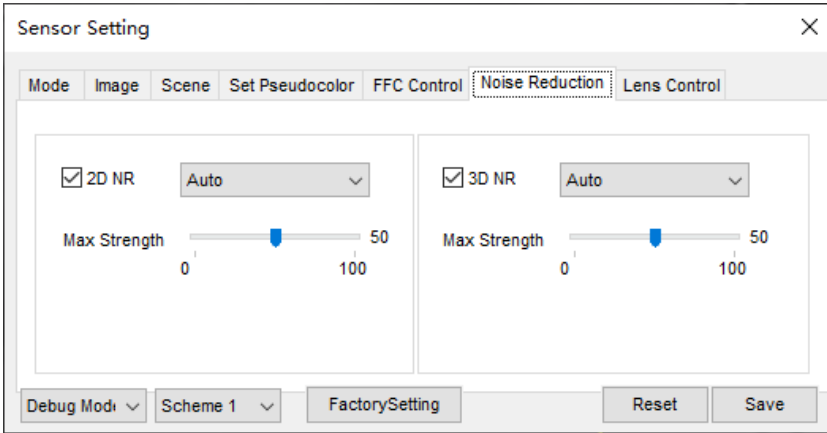

Table 8-4 lists the Noise reduction parameters.

Table 8-4 Parameters on the Noise reduction interface

Parameter	Description	Setting
2 DNR	Decrease the image noise.	[How to set] Select from the drop-down list box. Drag the slider to adjust max strength. [Default value] Auto
3 DNR	Decrease the image noise.	[How to set] Select from the drop-down list box. Drag the slider to adjust max strength. [Default value] Auto

---End

8.8 Lens Control

NOTE

The lens control is only used for motor lens.

Figure 8-8 shows the **Lens Control** interface.

Figure 8-8 Lens control interface

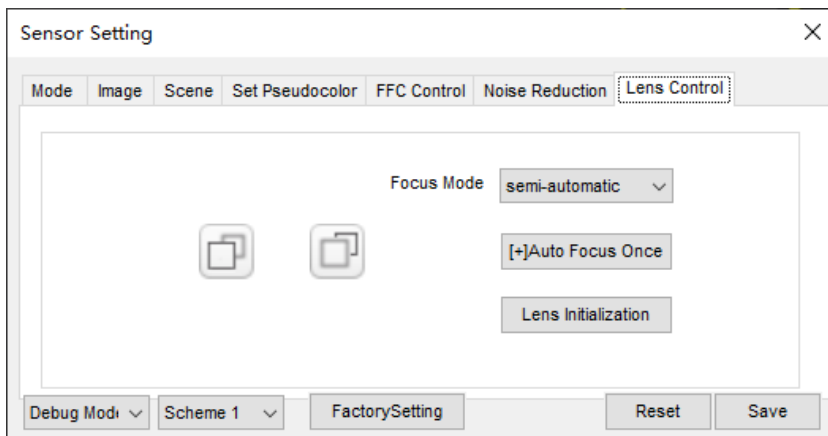

- Step 1 Click **Standard** in the lower left corner of Sensor Setting, and choose **lens control**.
- Step 2 Click “Near focus” or “Far focus” to focus automatically.
- Step 3 Choose focus mode, there are two modes can be chosen, semi-automatic and manual.
- Step 4 Click “Auto focus once” to focus once.
- Step 5 Click “Lens initialization” to initialize the lens.
- Step 6 Click **Save**, the message "Save succeed" is displayed, the system saves the settings.

---End

A Troubleshooting

Common Trouble	Possible Cause	Solution
Unable to access the web	Network is not connected.	<ul style="list-style-type: none"> • Connect the network cable of the camera to the PC to check whether the network cable is in good contact. • Run the ping command to check the network connection and whether the device works normally.
	IP address is occupied.	Directly connect the camera to the PC, and reset the IP address of the camera.
	The IP addresses of the PC and the device are in different networks.	Check the IP address, subnet mask and gateway setting of the camera.
PTZ or high-speed dome is out of control.	The protocol, bit-rate, or address setting of the PTZ is incorrect.	Modify the address of the PTZ on the web.
	The signal cable is unconnected or not connected correctly.	Check the signal strength, and reconnect the signal cable.
The measured temperature is not accurate.	The device is just powered on, and the temperature of the cavity is unstable.	The temperature of the cavity is stable within 15 to 30 min after the device is powered on.
	The FFC mode is incorrect.	The FFC mode is auto by default. If the mode is set to manual, it will be no block calibration, which may lead to fuzzy pictures and inaccurate temperature.
	The target configuration is incorrect.	Check whether the emission rate and distance of the target are configured correctly.

Common Trouble	Possible Cause	Solution
<p>An error occurs in accessing the web of the device after the upgrade.</p>	<p>The data in the cache of browser is not updated in time.</p>	<p>Delete the cache of the Internet Explorer. The steps are as follows (taking IE9 as an example):</p> <ol style="list-style-type: none"> 1. Open the Internet Explorer. 2. Select Tools > Internet Options. 3. On the General tab, select Delete under Browsing history. The Delete Browsing History dialog box appears. 4. Select all check boxes. 5. Click Delete. <p>Login again the web page of the camera.</p>
<p>Upgrade failed.</p>	<ul style="list-style-type: none"> • No network cable is connected. • The network setting is incorrect. 	<ul style="list-style-type: none"> • Ensure the upgrade network is connected. • Check whether the network setting is correct.
	<p>The upgrade package is incorrect.</p>	<p>Perform the correct upgrade package again.</p>

B Common Emission Rate

The emission rate is the capability of an object to emit or absorb energy. An ideal transmitter provides an emission rate of emitting 100% of intake energy. An object with an emission rate of 0.8 can absorb 80% of intake energy, and reflect the remaining 20%. The emission rate is the ratio of the energy emitted by an object at a specific temperature to that emitted by an ideal radiator at the same temperature. The range of emission rate value is 0.0 to 1.0 generally.

Materials	Temperature (°C/°F)	Emissivity
Gold (High-purity)	227/440	0.02
Aluminum foil	27/81	0.04
Aluminum sheet	27/81	0.18
Aluminum used for families (flat)	23/73	0.01
Aluminum plate (98.3% purity)	227/440	0.04
	577/1070	0.06
Aluminum plate (rough)	26/78	0.06
Aluminum (oxidized @ 599°C)	199/390	0.11
	599/1110	0.19
Polished aluminum	38/100	0.22
Tin (light tinned Iron sheet)	25/77	0.04
Nickel wire	187/368	0.1
Lead (99.9% purity, No oxidized)	127/260	0.06
Copper	199/390	0.18

Cobalt	599/111	0.19
Steel	199/390	0.52
	599/1110	0.57
Tinned iron sheet (Light)	28/82	0.23
Brass(High-polish)	247/476	0.03
Brass (Tough rolled, polished metal wire)	21/70	0.04
Tinned Iron (Light)	-	0.13
Iron plate (Rust eaten)	20/68	0.69
Rolled steel sheet	21/71	0.66
Ferric oxide	100/212	0.74
Wrought-iron	21/70	0.94
Fused iron	1299-1399/3270-2550	0.29
Copper (Polished)	21-117/70-242	0.02
Copper(Polished, not reflected)	22/72	0.07
Copper (Heavy oxide Board)	25/77	0.78
Enamel (Fuse on iron)	19/66	0.9
Formica Plate	27/81	0.94
Frozen soil	-	0.93
Brick (Red, rough)	21/70	0.93
Brick (Unglazed, rough)	1000/1832	0.8
Carbon (T - carbon 0.9% ash)	127/260	0.81

Concrete	-	0.94
Glass (Glossy)	22/72	0.94
Granite (Surfaced)	21/70	0.85
Ice	0/32	0.97
Marble (I Polished, grey)	22/72	0.93
Asbestos board	23/74	0.96
Asbestos paper	38/100	0.93
	371/700	0.95
Asphalt (Paving the road)	4/39	0.97
Paper (Black tar)	-	0.93
Paper (White)	-	0.95
Plastic (White)	-	0.91
plywood	19/66	0.96
Water	-	0.95
Wood (Fresh scent)	-	0.9

101-200-0148-02