

# Quick Setup Guide

## Mini Network High Speed Dome



### CAUTION

- Avoid heavy loads, intensive shakes, and soaking to prevent damages during transportation and storage. The warranty does not cover any device damage that is caused during secondary packaging and transportation after the original packaging is taken apart.
- Protect this device from fall-down and intensive strikes, keep the device away from magnetic field interference, and do not install the device in places with shaking surfaces or under shocks.
- Clean the device with a soft dry cloth. For stubborn dirt, dip the cloth into slight neutral cleanser, gently wipe the dirt with the cloth, and then dry the device.
- Do not jam the ventilation opening. Follow the installation instructions provided in this document when installing the device.
- Keep the device away from heat sources such as radiators, electric heaters, or other heat equipment.
- Keep the device away from moist, dusty, extremely hot or cold places, or places with strong electric radiation.
- If the device is installed outdoors, take insect- and moisture-proof measures to avoid circuit board corrosion that can affect monitoring.
- Remove the power plug if the device is idle for a long time.
- Before unpacking, check whether the fragile sticker is damaged. If the fragile sticker is damaged, contact customer services or sales personnel. The manufacturer shall not be held responsible for any artificial damage of the fragile sticker.

## Precautions

Fully understand this document before using this device, and strictly observe rules in this document when using this device. If you install this device in public places, provide the tip "You have entered the area of electronic surveillance" in an eye-catching place. Failure to correctly use electrical products may cause fire and severe injuries.

	<b>WARNING</b>	It alerts you to moderate dangers which, if not avoided, may cause minor or moderate injuries.
	<b>CAUTION</b>	It alerts you to risks. Neglect of these risks may cause device damage, data loss, device performance deterioration, or unpredictable results.
	<b>NOTE</b>	It provides additional information.

### WARNING

- Strictly observe installation requirements when installing the device. The manufacturer shall not be held responsible for device damage caused by users' non-conformance to these requirements.
- Strictly conform to local electrical safety standards and use power adapters that are marked with the LPS standard when installing and using this device. Otherwise, this device may be damaged.
- Use accessories delivered with this device. The voltage must meet input voltage requirements for this device.
- If this device is installed in places with unsteady voltage, ground this device to discharge high energy such as electrical surges in order to prevent the power supply from burning out.
- When this device is in use, ensure that no water or any liquid flows into the device. If water or liquid unexpectedly flows into the device, immediately power off the device and disconnect all cables (such as power cables and network cables) from this device.
- Do not focus strong light (such as lighted bulbs or sunlight) on this device. Otherwise, the service life of the image sensor may be shortened.
- If this device is installed in places where thunder and lightning frequently occur, ground the device nearby to discharge high energy such as thunder strikes in order to prevent device damage.

## Special Announcement

- All complete products sold by the manufacturer are delivered along with nameplates, quick setup guide and accessories after strict inspection. The manufacturer shall not be held responsible for counterfeit products.
- The manufacturer will update this manual according to product function enhancement or changes and regularly update the software and hardware described in this manual. Update information will be added to new versions of this manual without prior notice.
- This manual may contain misprints, technology information that is not accurate enough, or product function and operation description that is slightly inconsistent with the actual product, the final interpretation of company is as a standard.
- This manual is only for reference and does not ensure that the information is totally consistent with the actual product. For consistency, see the actual product.

### NOTE

For more information, please refer to website.

## Open package Examination

Open the package, check the appearance of product for no obvious damage, and confirm the item list for table 1-1 is consistent.

Table 1-1 Packing list

Component	Quantity	Remark
Mini High Speed Dome Camera	1	
Quick Setup Guide	1	
Power Adapter	1	
A Pair of Gloves	1	
Stainless Hexagon Screws	2	
Connector	1	
"L"Hex Wrench	1	
Wall Mounting Bracket	1	Optional
Installation Location Sticker	1	
Expansion Bolts	4	

## Device Structure

### 2.1 Device Ports

Figure 2-1 Hardware Ports

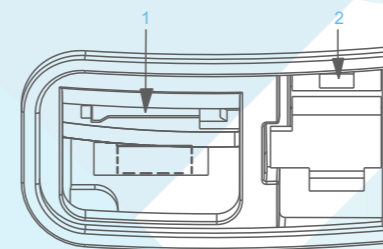

Table 2-1 Hardware Ports Description

ID	Ports Name	Description
1	SD Card slot	Install a SD card. <b>Note</b> <ul style="list-style-type: none"> <li>• Before installing a SD card, verify the card not in write protection state.</li> <li>• Before removing the SD card. Verify the card not in write protection state. Otherwise, the data may be lost, or the SD card may be damaged.</li> <li>• Before installing or removing a SD card when the camera is running, stop video recording first.</li> </ul>
2	Reset button	Restore the camera to the factory settings by pressing and holding this button for more than five seconds.

Figure 2-2 Multi-head cable

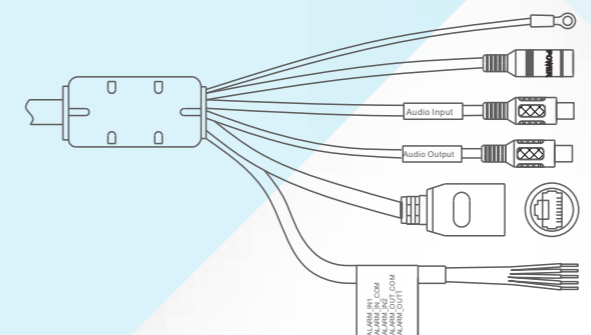
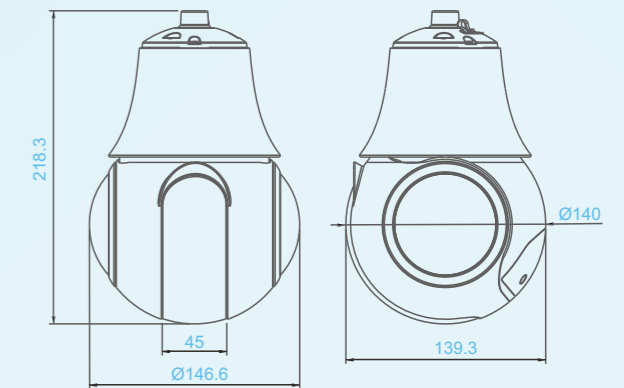

Table 2-2 Multi-head cable Description

ID	Core	Description	Remark
1	Grounding wire	-	
2	Power port	DC 12V power supply wire	
3	Audio input	Receive analog audio signals from devices such as a sound pickup device.	Applied for audio function
4	Audio output	Connect to an external active audio device such as a speaker.	
5	Network port	Connect a standard Ethernet cable.	
6	Purple	Alarm input channel 1	Connect alarm input device Applied for alarm function
	Grey	Alarm input channel common terminal	
	Yellow	Alarm input channel 2	
	Orange	Alarm output channel common terminal	Connect alarm output device
	White	Alarm output channel 1	

### 2.2 Device Dimensions

Figure 2-3 Dimensions(unit:mm)



## Device Installation

### 3.1 Installation Modes

The Mini PTZ supports wall mounting , pendant mounting and ceiling mounting.

### 3.2 Installation Steps

Step1 Open the SD card cover in the bottom of the PTZ, remove the shake-proof metal block, insert in SD card, then fasten the SD card cover.

### CAUTION

Please reserve the metal block. Insert the metal block to prevent the damage for PTZ model when transport again.

Figure 3-1 Removing the shake-proof metal block

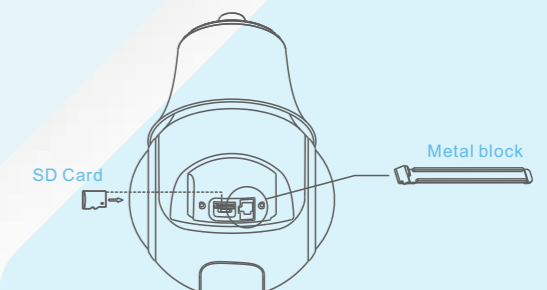

- Step 2 Stick the installation location sticker on the Installation surface, drill four holes these are 50mm deep, based on the marks on the sticker. Drive the expansion bolts into the holes.
- Step 3 Attach the PTZ camera, thread the multi-head cable through the connector, install the camera to the installation panel, and tighten the lock screws, as shown in figure 3-2.
- Step 4 Thread the multi-head cable through the bracket (walling mounting/ pendant mounting/ ceiling mounting). Connect the bracket with connector, tighten the lock screws of bracket.
- Step 5 Put the bracket to match the expansion bolts, fix the bracket with nuts.

Figure 3-2 Wall mounting

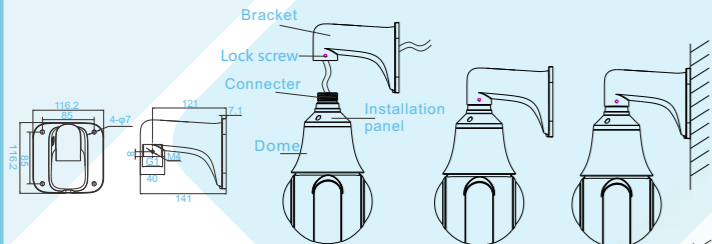

Installation of junction box(optional):

1. Stick the installation location sticker on the installation surface, Drill four holes these are 50mm deep, based on the marks on the sticker. Drive the expansion bolts into the holes, fix the box to the bolts with the screws.
2. Camera is connected to the bracket. Fix the bracket to junction box with screws.

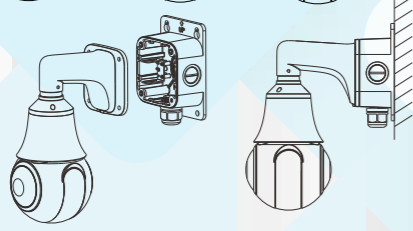

Figure 3-3 Pendant mounting

Dimensions of pendant/ceiling mounting bracket (unit: mm)

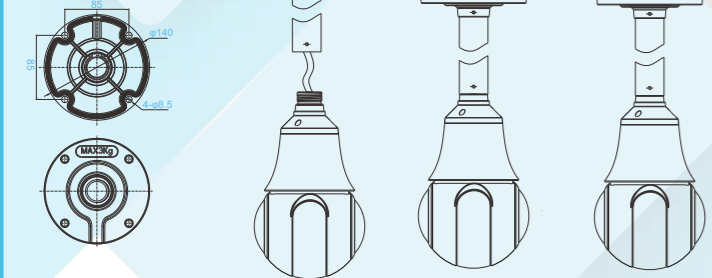

Figure 3-4 Ceiling Mounting



You can route cables from the top or from the side. If you use the top routing method, drill a hole in the installation surface first. If you use the side routing method, please cut the outlet, as shown in figure 3-3, and route the multi-head cable out from the side gap.

## Quick Configuration (e.g IE)

### 4.1 Login

- Step 1 Open the Internet Explorer, enter the IP address of IP camera (default value: 192.168.0.120) in the address box, and press Enter. The login page is displayed as shown in figure 4-1.
- Step 2 Input the user name and password.



- The default user name is **admin**. The default password is **admin**. Change the password when you log in the system for first time to ensure system security.
- You can change the system display language on the login page.

Figure 4-1 Login

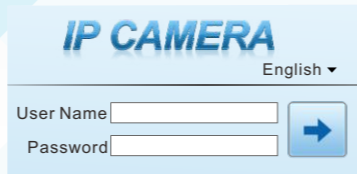

- Step 3 Click , the main page is displayed.

### 4.2 Modify IP address

Choose Configuration > Device > Local Network, the Local Network page is displayed. Enter the IP address in the IP Address box and click Apply as shown in figure 4-2. After the IP address is set successfully, please use the new IP address to log in the Web interface.

Figure 4-2 Local Network



### 4.3 Browsing Video

To ensure the real-time video can be played properly, you must perform the following operation when you log in the web for the first time: If you can view the video directly, you can ignore the step of adding trusted sites.

- Step1 Open the Internet Explorer. Choose **Tools > Internet options > Security > Trusted sites > Sites**, in the display dialog box, click **Add**, as shown in figure 4-3. If you can view the video directly, please ignore this step.

Figure 4-3 Adding a trusted site

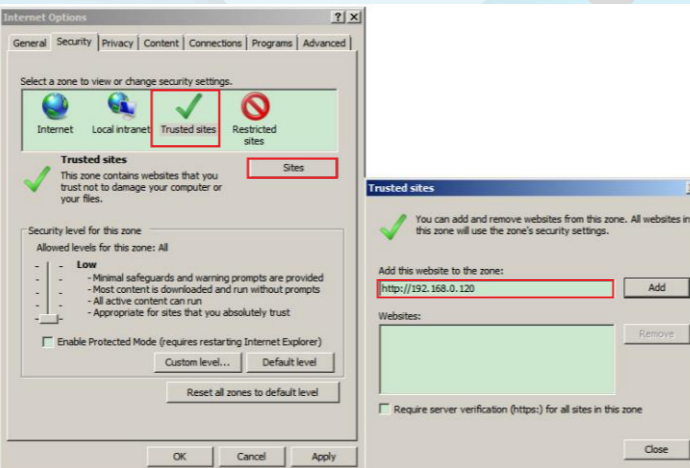

- Step 2 In the Internet Explorer, choose **Tool > Internet Options > Security > Customer level**, and set **Download unsigned ActiveX control and initialize and script ActiveX controls not marked as safe for scripting under ActiveX controls and plug-ins to Enable**, as shown in figure 4-4.

Figure 4-4 Configuring ActiveX control and plug-in

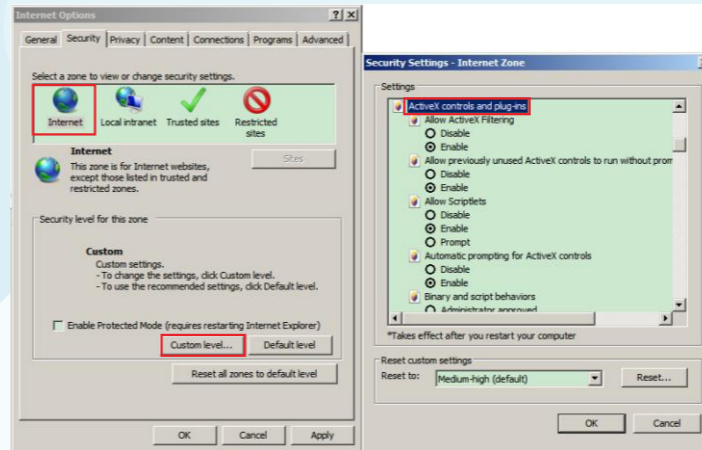

- Step 3 Download and install the player control as prompted.



If the repair tips displayed when installing the control, please ignore the prompt, and continue the installation, the login page is displayed when the control is loaded.

To browse a real-time video, click Live Video. The Live Video page is displayed, as shown in figure 4-5.

Figure 4-5 Live Video

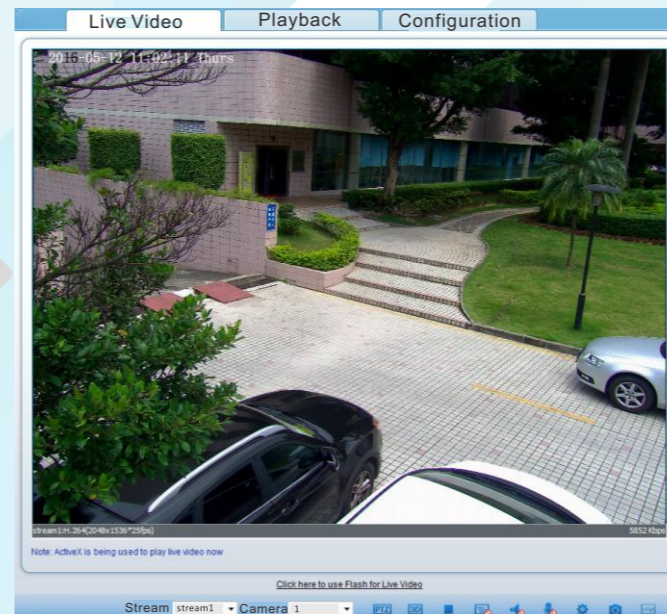

### 4.4 Two-way audio



Partial cameras do not support two-way audio, this section do not apply.

#### 4.4.1 Camera → PC

- Connection:
- Step 1 Connect microphone to audio input interface of camera.
  - Step 2 Connect speaker to the PC audio output interface.
  - Step 3 Log in camera Web, click to turn on two-way audio.

#### 4.4.2 PC → Camera

- Step 1 Connect microphone to PC audio input interface.
- Step 2 Connect speaker to camera audio out interface.
- Step 3 Log in camera Web, click to turn on two-way audio.

### 4.5 Alarm configuration



Partial cameras do not support alarm, this section do not apply.

#### Alarm input and Alarm output connection:

- Step 1 Connect alarm input device to Alarm IN0 and Alarm COM0 of multi-head cable.
- Step 2 Connect alarm output device to Alarm OUT1 and Alarm COM1 of multi-head cable, alarm output interface can connect to normal open device only.
- Step 3 Log in Web, Choose **Configuration > Alarm > Alarm Output**, set the parameters as shown in figure 4-6.
- Step 4 Choose **Configuration > Alarm > I/O Alarm Linkage**, enable the I/O Alarm and set the parameters of Schedule Setting.

Figure 4-6 Alarm

