

Thermal Imaging Box Network Camera User Manual

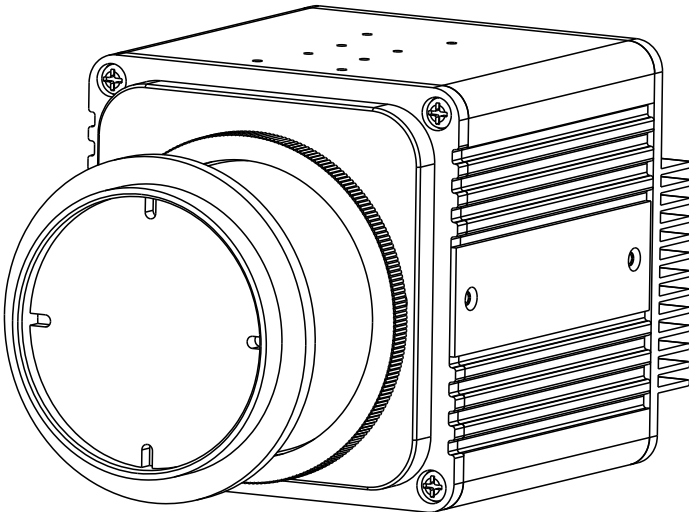

Issue

V1.0

Date

2019-08-06





Precautions

Precautions

Fully understand this document before using this device, and strictly observe rules in this document when using this device. If you install this device in public places, provide the tip "You have entered the area of electronic surveillance" in an eye-catching place. Failure to correctly use electrical products may cause fire and severe injuries. To prevent accidents, carefully read the following context:

Symbols

This document may contain the following symbols whose meanings are described accordingly.

Symbol	Description
 DANGER	It alerts you to fatal dangers which, if not avoided, may cause deaths or severe injuries.
 WARNING	It alerts you to moderate dangers which, if not avoided, may cause minor or moderate injuries.
 CAUTION	It alerts you to risks. Neglect of these risks may cause device damage, data loss, device performance deterioration, or unpredictable results.
 TIP	It provides a tip that may help you resolve problems or save time.
 NOTE	It provides additional information.

DANGER

To prevent electric shocks or other dangers, keep power plugs dry and clean.

WARNING

- Strictly observe installation requirements when installing the device. The manufacturer shall not be held responsible for device damage caused by users' non-conformance to these requirements.

- Strictly conform to local electrical safety standards and use power adapters that are marked with the LPS standard when installing and using this device. Otherwise, this device may be damaged.
- Use accessories delivered with this device. The voltage must meet input voltage requirements for this device.
- If this device is installed in places with unsteady voltage, ground this device to discharge high energy such as electrical surges in order to prevent the power supply from burning out.
- When this device is in use, ensure that no water or any liquid flows into the device. If water or liquid unexpectedly flows into the device, immediately power off the device and disconnect all cables (such as power cables and network cables) from this device.
- Do not place the thermal imaging camera and unpackaged products at a radiation source with a high intensity regardless of whether the device is in the normal power-on state, for example, the sun, laser, and electric arc welder, and place the thermal imaging camera and unpackaged products against objects with a high heat source, for example, the sun. Otherwise, the accuracy of the thermal imaging camera will be affected. In addition, the detector in the thermal imaging camera may be permanently damaged.
- If this device is installed in places where thunder and lightning frequently occur, ground the device nearby to discharge high energy such as thunder strikes in order to prevent device damage.

**CAUTION**

- Unless otherwise specified in the user manual, do not use the thermal imaging camera in an environment with the temperature lower than -10°C ($+14^{\circ}\text{F}$) or higher than 50°C ($+122^{\circ}\text{F}$). Otherwise, the images displayed by the thermal imaging camera are abnormal and the device may be damaged if working beyond the temperature range for a long period.
- During the outdoor installation, prevent the morning or evening sunlight incidence to the lens of the thermal imaging camera. The sun shade must be installed and adjusted according to the angle of the sunlight illumination.
- Avoid heavy loads, intensive shakes, and soaking to prevent damages during transportation and storage. The warranty does not cover any device damage that is caused during secondary packaging and transportation after the original packaging is taken apart.
- This device is a static sensitivity device. Improper static may damage the thermal imaging camera. ESD protection measures and reliable grounding must be well prepared for device installation and uninstallation.
- Protect this device from fall-down and intensive strikes, keep the device away from magnetic field interference, and do not install the device in places with shaking surfaces or under shocks.

- Use a soft and dry cloth to clean the device body. In case that the dirt is hard to remove, use a dry cloth dipped in a small amount of mild detergent and gently wipe the device, and then dry it again. Pay special attention to the front window of the thermal imaging camera because this is precision optics. If the front window has water spots, use a clean and soft cloth to moisten with water and wipe it. If the front window needs further cleaning, use a soft cloth dampened with isopropyl alcohol or detergent. Improper cleaning can cause damage to the device.
- The lens window of the thermal imaging camera is designed to be applicable to an outdoor environment. The window is coated with durable coating material, but may require frequent cleaning. When you found lens image degradation or excessive accumulation of pollutants, you should clear up the window in a timely manner. Exercise caution when you use this device in severe sandstorm (such as deserts) or corrosive environments (such as offshore). Improper use may cause surface coating off.
- Do not jam the ventilation opening. Follow the installation instructions provided in this document when installing the device.
- Keep the device away from heat sources such as radiators, electric heaters, or other heat equipment.
- Keep the device away from moist, dusty, extremely hot or cold places, or places with strong electric radiation.
- If the device is installed outdoors, take insect- and moisture-proof measures to avoid circuit board corrosion that can affect monitoring.
- Remove the power plug if the device is idle for a long time.
- Before unpacking, check whether the fragile sticker is damaged. If the fragile sticker is damaged, contact customer services or sales personnel. The manufacturer shall not be held responsible for any artificial damage of the fragile sticker.

Special Announcement

All complete products sold by the manufacturer are delivered along with nameplates, operation instructions, and accessories after strict inspection. The manufacturer shall not be held responsible for counterfeit products.

This manual may contain misprints, technology information that is not accurate enough, or product function and operation description that is slightly inconsistent with the actual product. The manufacturer will update this manual according to product function enhancement or changes and regularly update the software and hardware described in this manual. Update information will be added to new versions of this manual without prior notice.

This manual is only for reference and does not ensure that the information is totally consistent with the actual product. For consistency, see the actual product.

Contents

1 Product Overview	1
1.1 Thermal Imaging Principles and Advantages	1
1.2 Device Structure	1
1.3 Cable Connection	2
1.4 Functions and Features	4
2 Device Dimensions	5
3 Installation	6
3.1 Preparations	6
3.2 Installation Mode	6
3.3 Installation Procedure	6
4 Quick Configuration	9
4.1 Login and Logout	9
4.2 Main Page layout	10
4.3 Change the Password	12
4.4 Browse Video	13
4.4.1 Install Plugins	15
4.5 Setting Local Network Parameters	15
5 Thermal Setting	18
5.1 Temperature Parameters	18
5.2 Temperature Area	22
5.3 Shield Area	25
5.4 Schedule Linkage	26
5.5 Bad Point Check	27
5.6 Version Information	28
6 Parameter Setting	29
6.1 Sensor Setting Interface	29
6.2 Time Segment	30
6.3 Image Setting	30
6.4 Scene	31
6.5 Pseudocolor	32

6.6 FFC Control	33
6.7 Noise Reduction	35
6.8 Enhance Image	36
7 Technical Specifications	37
A Troubleshooting.....	42
B Common Emission Rate.....	44

1 Product Overview

1.1 Thermal Imaging Principles and Advantages

For any object, as long as its temperature is above the absolute zero (-273.15°C), although the object does not give out light, it can radiate infrared. The infrared is also known as thermal radiation. A temperature change occurs when the infrared radiated by objects at different temperatures is absorbed by the infrared thermal detector, and thereby generating an electrical effect. An electrical signal is amplified and processed to obtain a thermal image corresponding to the distribution of heat on the surface of the object, that is, infrared thermal imaging.

- Applicable to any light environment

Traditional cameras rely on the natural or ambient light for imaging. However, the infrared thermal imaging camera can clearly image the object with the infrared heat radiation of the object without relying on any light. The infrared thermal camera is applicable to any light environment and is free from glare impact. It can clearly detect and find the target as well as identify the camouflaged and hidden target in both day and night. Therefore, it achieves real 24-hour surveillance.

- Monitoring the temperature field of the target heat distribution

The infrared thermal camera can display the temperature field of the object and change the surface temperature distribution of the object that cannot be directly seen by human eyes to the thermal image representing the surface temperature distribution of the object. By monitoring the temperature field, you can immediately identify the temperature abnormality, thereby preventing potential risks caused by the temperature, such as fire.

- Providing the cloud penetration capability

Atmosphere, dust, and clouds can absorb visible light and near infrared, but are clear to the thermal infrared for 3 to 5 microns (medium wave infrared region) and 8 to 14 micron (long wave infrared). Therefore, it is difficult for the conventional cameras to capture clear images under dense clouds, while the thermal imaging camera is able to effectively penetrate the atmosphere and clouds to capture clear images.

1.2 Device Structure

Figure 1-1 shows the rear panel of the thermal imaging box network camera. For details about the interfaces, see Table 1-1.

Figure 1-1 Appearance and interfaces of device

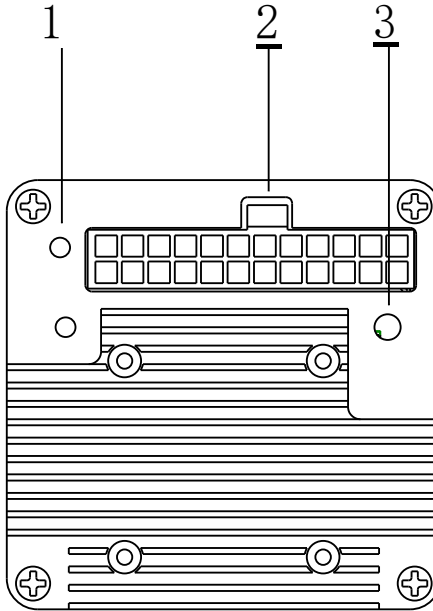

Table 1-1 Interfaces

No.	Physical Interface	Connection
1	Power indicator	Indicates the power status
2	Connector	Connector of multi-connector combination cable
3	Reset button (RESET)	The configuration resumes to the factory settings after you press the reset button for 3s. The default value of IP is 192.168.0.121.

1.3 Cable Connection

Figure 1-2 the multi-connector combination cable of the thermal imaging box network camera. For details about the multi-connector combination cable, see Table 1-2.

Figure 1-2 Multi-connector combination cable



Table 1-2 Multi-connector combination cable

ID	Functions	Connection
1	Alarm out	Connects to the external alarm out device, such as alarm light.
2	Alarm in	Inputs the alarm signal, such as doorbell.
3	Audio input	Inputs the audio signal and receives the analog audio signals from the sound pick-up device.
4	Audio output	Connects to the external audio device such as the speaker.
5	Network interface	Connects to the standard Ethernet cable.
6	Motor focus	Connects to the input interface of pan focusing signal cable.
7	Power interface	Connects to the 12 V DC power supply.

ID	Functions	Connection
8	Analog video interface	Sends analog video signals. User can connect the camera to a TV monitor through this port to view analog videos.
9	RS 485/12 V	Connects to the external pan & tilt/ Connects to a fan.

1.4 Functions and Features

- Using the uncooled infrared focal plane sensor.
- Detecting the infrared wavelength ranging from 8 um to 14 um.
- 800*600 pixels.
- High thermal sensitivity, reaching 40 Mk.
- Support dedicated lens for 8/15/25/35/50 mm focal distance (optional), and motor lens for 8/25/50/75 / 100 mm (optional).
- Support 17 pseudo color modes such as black hot, white hot, rainbow, iron bow and so on.
- Support the DVE image enhancement.
- Support noise reduction and mirroring.
- Support three coding algorithms, these are H. 265, H. 264 and MJPEG, high compatibility.
- In the heat setting temperature measuring points in the image or temperature area, temperature detection and display: point temperature measurement, regional temperature measuring, full screen (the highest temperature, the lowest temperature and the average temperature) temperature measurement. User can set over temperature warning and over temperature alarm.
- Output two code streams in real time, and satisfying local storage and network transmission of the video.
- 1-channel audio input and 1-channel audio output, supporting bidirectional voice talkback.
- Support the local storage, NAS storage, Micro SD card (the maximum capacity is 128 GB) and effectively resolving the video loss problem caused by network failure.
- Provide software and hardware watchdogs and automatic fault recovery.
- Linked heat dissipation structure of the metal enclosure.
- DC 12 V.

2 Device Dimensions

Figure 2-1 shows the dimensions of the thermal imaging box network camera.

Figure 2-1 Dimensions of 25 mm prime lens (unit: mm)

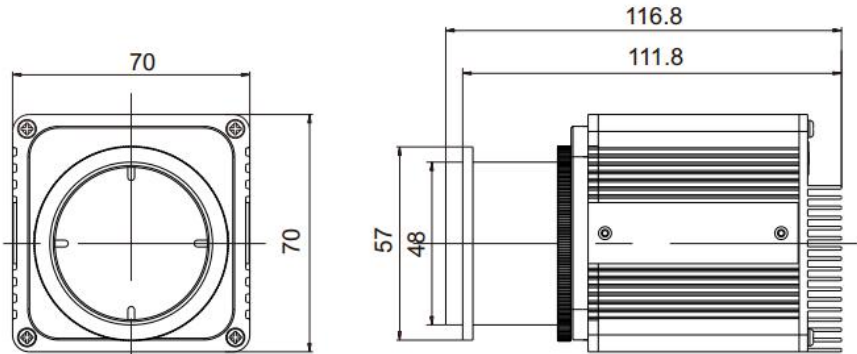

3 Installation

3.1 Preparations

User need the tools and accessories shown in Table 3-1 during the installation (you need to prepare the tools by yourself, and the accessories are in the package of the camera).

Table 3-1 Installation tools

Tools	Appearance
Phillips screwdriver (prepare by yourself)	

3.2 Installation Mode

If the thermal imaging box camera is installed indoor, a bracket should be selected; if the thermal imaging box camera is installed outdoor, a shield should be selected.

NOTE

The wall where the support is mounted must be able to withstand at least three times of the total weight of the support and the camera.

3.3 Installation Procedure

- Step 1 Remove the installation block delivered with the camera. Fix the installation block on the top or on the bottom of the camera, as shown in Figure 3-1.

Figure 3-1 Fix the installation block

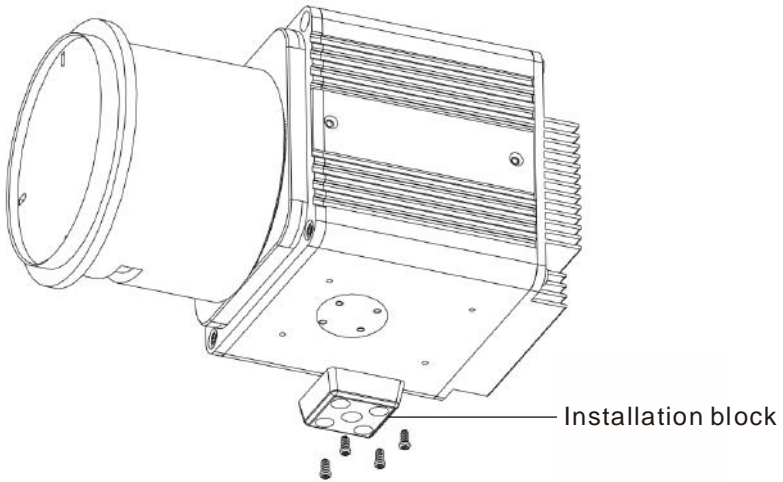

Step 2 Fix the installation block and mounting bracket, as shown in Figure 3-2.

Figure 3-2 Fix installation block and mount bracket

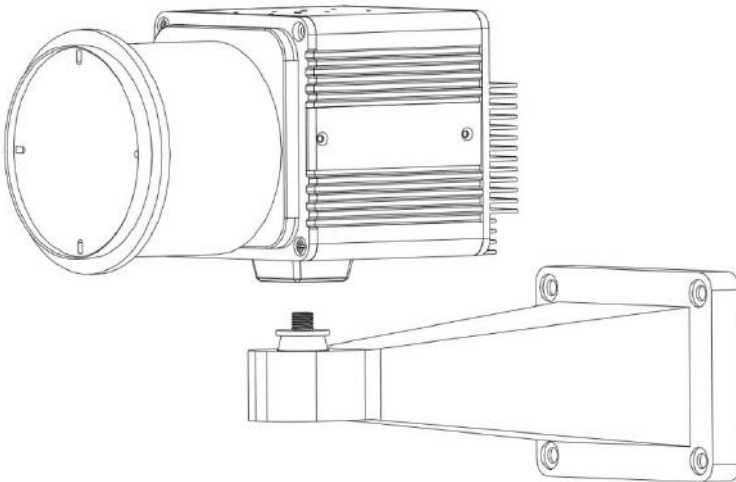

Step 3 Fix the mounting bracket on the wall, as shown in Figure 3-3.

Figure 3-3 Fix the mounting bracket

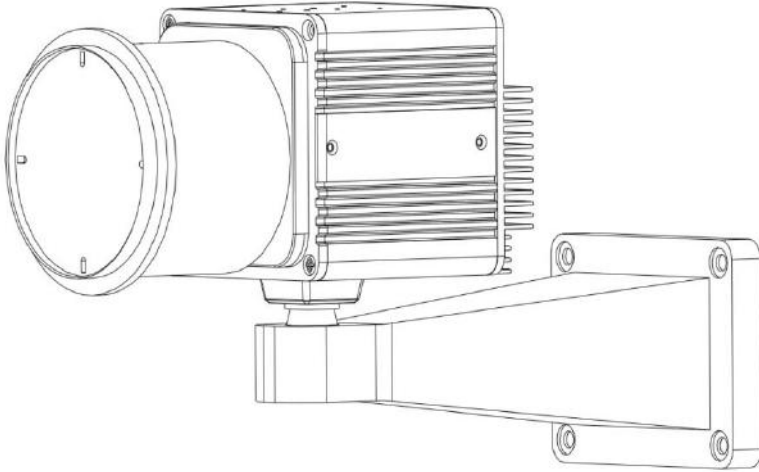
**Step 4 Focus with focusing screw**

Insert the focusing screw into the screw hole and focus along the direction of arrows as shown in Figure 3-4.

Figure 3-4 Focus with focusing screw

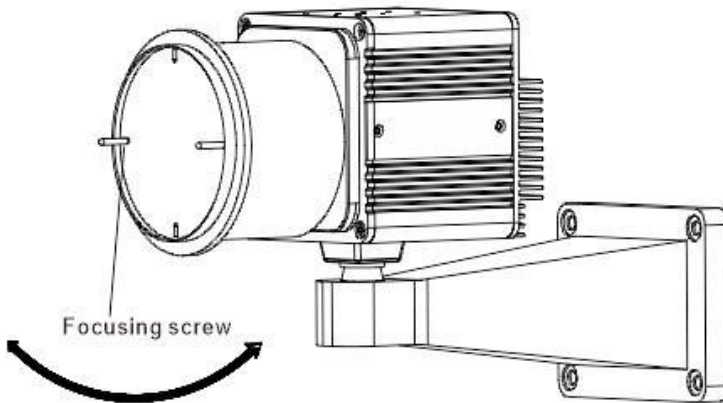

----End

4 Quick Configuration

4.1 Login and Logout



CAUTION

You must use Internet Explorer 8 or a later version to access the web management system; otherwise, some functions may be unavailable.

Login system

Step 1 Open the Internet Explorer, enter the IP address of IP camera (default value: 192.168.0.121) in the address box, and press Enter.

The login page is displayed, as shown in Figure 4-1.

Figure 4-1 Login page

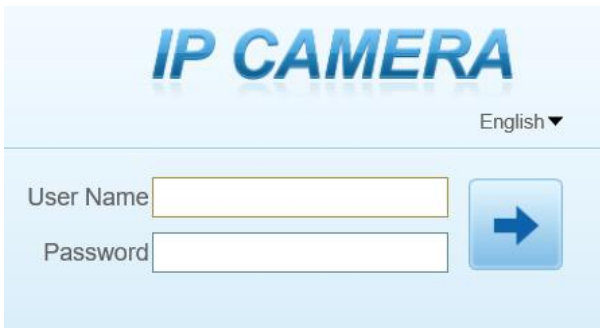

Step 2 Input the User and password.

NOTE

- The default name and password are both **admin**. Modify the password when you login the system for first time to ensure system security. After modifying password, you need to wait at least three minutes then power off to make sure modifying successfully . Or login the Web again to test the new password.
- You can change the system display language on the login page.

Step 3 Click Login arrow. The main page is displayed.

----End

logout

To logout of system, click  in the upper right corner of the main page, the login page is displayed after you log out of the system.

4.2 Main Page layout



On the main page, you can view real-time video, set parameter, Video parameter, Video control, and logout of the system. Figure 4-2 is shown the main page layout. Table 4-1 lists the elements on the main page layout.

Figure 4-2 Main page layout



Table 4-1 Elements on the main page

No.	Element	Description
1	Real-time video area	Real-time videos are played in this area. You can also set sensor parameters.
2	Playback	You can query the playback videos in this area.

No.	Element	Description
		 NOTE Only when the SD card or NAS have videos that user can query the playback videos.
3	Device configuration	You can choose a menu to set device parameters, including the device information, audio and video streams, alarm setting, and privacy mask function.
4	Change password	You can click  to change the password.
5	Sign Out	You can click  to return to the login page.
6	Stream	There are three streams. Choose one type from drop-down list.
7	Pause/Start	Close live video or play live video.
8	Live/Smooth	Switch image quality.
9	Audio	Open or close audio.
10	Interphone	Open or close interphone.
11	Sensor setting	Click the icon, it will access to sensor setting.
12	Snapshot	Click the icon, it will snapshot.
13	Local record	Click the icon, it will record video and save.
14	Intelligent analysis	Open or close intelligent analysis.

 **NOTE**





- When the device generates an alarm, the alarm icon  is displayed. You can click  to view the alarm information. When the device accepts an alarm signal, the alarm icon will display within 10s in the web management system.
- When the device encounters an exception, the fault icon  is displayed. You can click  to view the fault information.

Figure 4-3 The icon



: the lowest temperature in the full screen.

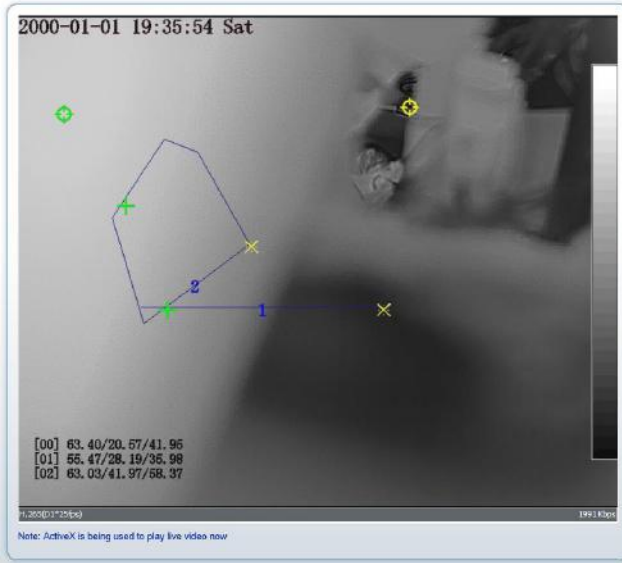

: the highest temperature in the full screen.



: the lowest temperature in the area.



: the highest temperature in the area.

----End

4.3 Change the Password

Description

You can click  to change the password for logging to the system.

Procedure

Step 1 Click  in the upper right corner of the main page.

The **Change Password** dialog box is displayed, as shown in Figure 4-4.

Figure 4-4 Modify Password dialog box

Change Password X

Old Password

New Password

Confirm

Password Advice:
1. Advice the password length of eight characters.
2. Advice the password includes numbers, capital letters, lowercase letters and special characters.
3. Advice the password can not be the same as username.

OK Cancel

NOTE

The change password page will be displayed if you don't change the default password when you login the system for the first time. User need to wait at least three minutes after changing password, and then restart the device. The password incorrect more than 3 times, please login again after 5 minutes

Step 2 Input the old password, new password, and confirmation password.

Step 3 Click **OK**.

If the message "Change own password success" is displayed, the password is successfully changed. If the password fails to be changed, the cause is displayed. (For example, the new password length couldn't be less than eight characters.)

Step 4 Click **OK**. The login page is displayed.

----End

4.4 Browse Video

User can browse the real-time video in the web management system.

Preparation

To ensure the real-time video can be play properly, you must perform the following operation when you login to the web for the first time:

Step 1 Open the Internet Explorer. **Choose Tools > Internet options > Security > Trusted sites > Sites.**

In the display dialog box, click **Add**, as shown in Figure 4-5.

Figure 4-5 Add the a trusted site

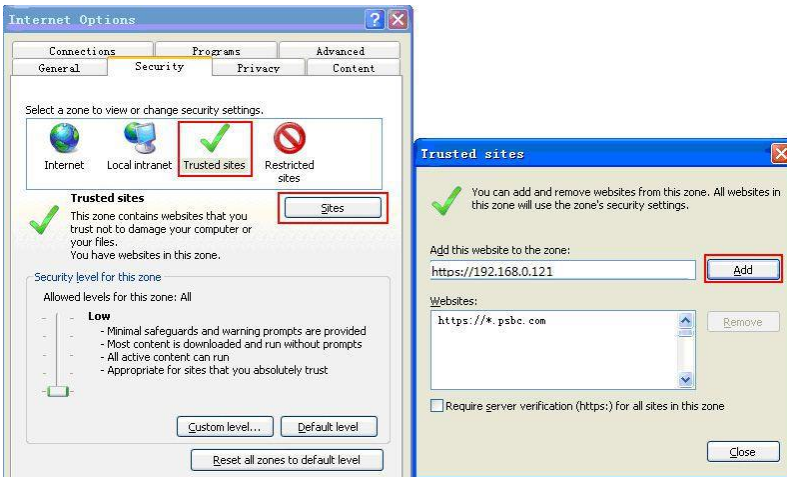

- Step 2 In the Internet Explorer, choose **Tool > Internet Options > Security > Customer level**, and set Download unsigned ActiveX control and initialize and script ActiveX controls not marked as safe for scripting under ActiveX controls and plug-ins to Enable, as shown in Figure 4-6.

Figure 4-6 Configuring ActiveX control and plug-ins

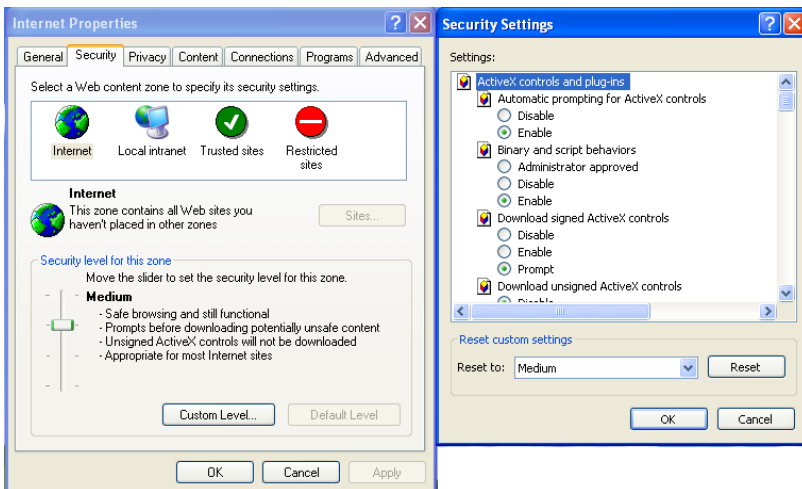

- Step 3 Download and install the player control as prompted.

 **NOTE**

The login page is displayed when the control is loaded.

4.4.1 Install Plugins

You will be prompted with a message “Download and install the new plugin” will show as in Figure 4-7, when you login to the web management system for the first time.

Figure 4-7 Install plugin

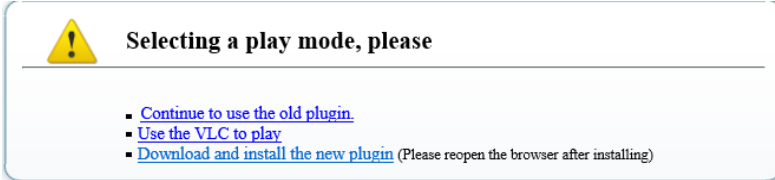

Procedure

- Step 1 Click the message, download and install the plugin follow the prompts.
- Step 2 During installing, user should close the browser.
- Step 3 Reopen the browser after installation.

----End

4.5 Setting Local Network Parameters

Description

Local network parameters include:

- IP protocol
- IP address
- Subnet mask
- Default gateway
- Dynamic Host Configuration Protocol (DHCP)
- Preferred Domain Name System (DNS) server
- Alternate DNS server
- MTU

Procedure

- Step 1 Choose **Configuration > Device >Local Network**.

The **Local Network** page is displayed, as shown in Figure 4-8.

Figure 4-8 Local Network page

Local Network

Network Card ID: 1

IP Protocol: IPv4

DHCP: OFF

IP Address: 192.168.0.121

Subnet Mask: 255.255.0.0

Default Gateway: 192.168.0.1

Preferred DNS Server: 192.168.0.1

Alternate DNS Server: 192.168.0.2

MTU(800-1500): 1500

Refresh Apply

Step 2 Set the parameters according to Table 4-2.

Table 4-2 Local network parameters

Parameter	Description	Setting
IP Protocol	IPv 4 is the IP protocol that uses an address length of 32 bits. IPv 6 is the IP protocol that uses an address length of 128 bits.	[Setting method] Select a value from the drop-down list box. [Default value] IPv4
DHCP	The device automatically obtains the IP address from the DHCP server.	[Setting method] Click the option button. NOTE To query the current IP address of the device, you must query it on the platform based on the device name.
DHCP IP	IP address that the DHCP server assigned to the device.	DHCP function is enabled.
IP Address	Device IP address that can be set as required.	[Setting method] Enter a value manually. [Default value] 192.168.0.121

Parameter	Description	Setting
Subnet Mask	Subnet mask of the network adapter.	[Setting method] Enter a value manually. [Default value] 255.255.255.0
Default Gateway	This parameter must be set if the client accesses the device through a gateway.	[Setting method] Enter a value manually. [Default value] 192.168.0.1
Preferred DNS Server	IP address of a DNS server.	[Setting method] Enter a value manually. [Default value] 192.168.0.1
Alternate DNS Server	IP address of a domain server. If the preferred DNS server is faulty, the device uses the alternate DNS server to resolve domain names.	[Setting method] Enter a value manually. [Default value] 192.168.0.2
MTU	Set the maximum value of network transmission data packets.	[Setting method] Enter a value manually. NOTE The MTU value ranges from 800 to 1500, the default value is 1500, Please do not change it arbitrarily.

Step 3 Click **OK**.

- If the message "Apply success" is displayed, click **OK**. The system saves the settings. The message "Set network param's success, Please login system again" is displayed. Use the new IP address to log in to the web management system.
- If the message "Invalid IP Address", "Invalid Subnet Mask", "Invalid default gateway", "Invalid primary DNS", or "Invalid space DNS" is displayed, set the parameters correctly.



NOTE

- If you set only the **Subnet Mask**, **Default Gateway**, **Preferred DNS Server**, and **Alternate DNS Server** parameters, you do not need to login to the system again.
- You can click **Reset** to set the parameters again if required.

----End

5 Thermal Setting

5.1 Temperature Parameters

Temperature parameters include temperature unit, ambient type, ambient temperature, cavity temperature, correctional coefficient, area temperature display mode, area temperature type, measure mode, and area alarm interval.

Operation Procedure

Step 1 Choose **Configuration > Thermal > Temperature Parameters**.

The **Temperature Parameters** page is displayed, as shown in Figure 5-1.

Figure 5-1 Temperature Parameters interface

 Temperature Parameters

Open Temperature Measure	<input checked="" type="checkbox"/>
Temperature Unit	Celsius
Ambient Temperature	25.00
Cavity Temperature	33.54
Correction Coefficient	0.00
Area Temperature Display Mode	Low Left
Font Border	<input type="checkbox"/> OFF
Custom Colors	<input type="checkbox"/> OFF
Area Temperature Type	Highest Temperature
Measure Mode	General
Display Alarm Area	<input type="checkbox"/> OFF
Area Alarm Interval(1-1800S)	10
Temperature Range	-40.0 ~ 150.0

Step 2 Set the parameters according to Table 5-1.

Table 5-1 Temperature parameters

Parameter	Description	Setting
Temperature Unit	Celsius and Fahrenheit temperature units are available.	[Setting method] Select a value from the drop-down list box. [Default value] Celsius
Ambient Temperature	The ambient temperature of camera. It is set when ambient is outside.	[Setting method] Enter a value manually.
Cavity Temperature	The cavity temperature of camera.	N/A
Correction Coefficient	Correction coefficient is refer to the deviation of measured object temperature and actual temperature. For example: 1. The measured object temperature is 30, and actual temperature is 37, so the correction coefficient should be 7 . 2. The measured object temperature is 37, and actual temperature is 30, so the correction coefficient should be -7 .	[Setting method] Enter a value manually. [Default value] 0.00
Area Temperature Display Mode	The display position of temperature information on the live-video image.	[Setting method] Select a value from the drop-down list box. [Default value] Low left
Custom Colors	Enable to custom the color, there are nine colors chosen.	[Setting method] Enable or disable [Default value] disable
Area Temperature Type	There are three types of area temperature.	[Setting method] Select a value from the drop-down list box. [Default value] Highest Temperature

Thermal Setting

Parameter	Description	Setting
Measure Mode	There are two types measure modes.	[Setting method] Select a value from the drop-down list box. [Default value] General
Display Alarm Area	N/A	[Setting method] Enable or disable [Default value] disable
Area Alarm Interval	N/A	[Setting method] Enter a value manually ranges from 1 to 1800. [Default value] 10

Figure 5-2 Advance Parameters interface

 Temperature Parameters

Open Temperature Measure ON

Temperature Unit Celsius ▾

Ambient Temperature

Cavity Temperature

Correction Coefficient

Area Temperature Display Mode Low Left ▾

Font Border OFF

Custom Colors OFF

Area Temperature Type Highest Temperature ▾

Measure Mode General ▾

Display Alarm Area OFF

Area Alarm Interval(1-1800S)

Temperature Range -40.0 ~ 150.0 ▾

Step 3 Set the parameters according to Table 5-1.

Figure 5-3 Advance Interface



Table 5-2 Advance parameters

Parameter	Description	Setting
Dimming Mode	There are auto and manual modes. It will show on temperature item.	[Setting method] Select a value from the drop-down list box. [Default value] Auto
Greater Prominent	Enable that, the image will show the setting color if the temperature is higher than set value.	[Setting method] Enter a value manually. Choose one color to show.
Section Prominent	Enable that, the image will show the setting color if the temperature is between minimum and maximum temperature.	[Setting method] Enter a value manually. Choose one color to show.
Less Prominent	Enable that, the image will show the setting color if the temperature is lower than set value.	[Setting method] Enter a value manually. Choose one color to show.

----End

5.2 Temperature Area

Operation Procedure

Step 1 Choose **Configuration > Thermal > Temperature Area**.

The **Temperature Area** page is displayed, as shown in Figure 5-4.

Figure 5-4 Temperature area and alarm configuration

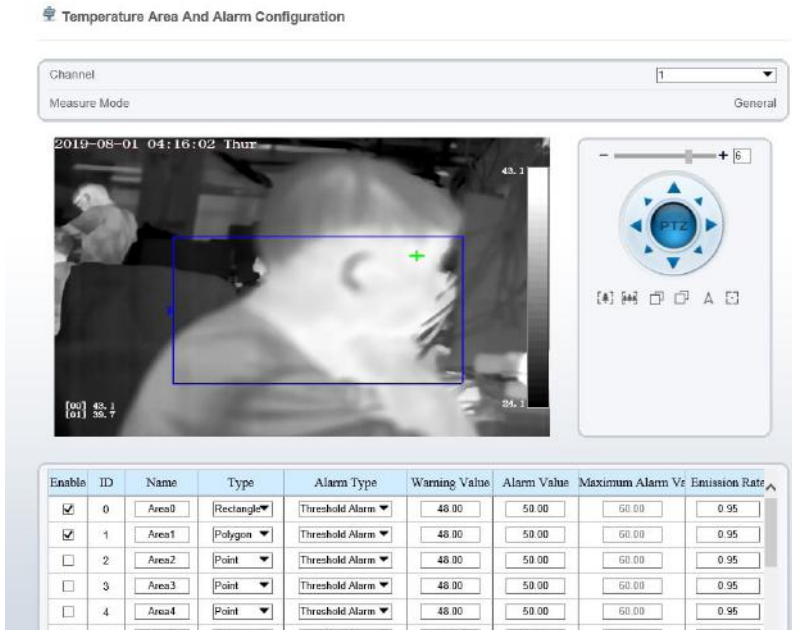

Step 2 Set the parameters according to Table 5-3.

Table 5-3 Temperature area and alarm configuration

Parameter	Description	Setting
Channel	N/A	[Setting method] Select a value from the drop-down list box. [Default value] 1
Measure Mode	Set at temperature parameter interface.	N/A
Enable	Tick to enable the areas	N/A
ID	It ranges from 0 to 19	N/A

Parameter	Description	Setting
Name	Area name of temperature area.	[Setting method] Enter a value manually.
Type	Type of temperature area. ID 0 is default rectangle area, which is full screen.	[Setting method] Select a value from the drop-down list box. [Default value] Rectangle/Point
Alarm Type	Threshold alarm, Section Alarm and Temperature difference alarm are available for alarm type.	[Setting method] Select a value from the drop-down list box. [Default value] Threshold alarm
Warning Value	Camera will warn when the surveillance object temperature reaches the warning value. At threshold alarm type and difference alarm type can be set.	[Setting method] Enter a value manually. [Default value] 48.00
Alarm Value	Camera will alarm when the surveillance object temperature reaches the alarm value.	[Setting method] Enter a value manually. [Default value] 50.00
Maximum Alarm Value	At Section alarm type, the device would not alarm when the temperature is higher than maximum alarm value.	[Setting method] Enter a value manually. [Default value] 60.00
Emission Rate	The emission rate is the capability of an object to emit or absorb energy. The emission rate should be set only when the target is special material. The emission rate list refers to B Common Emission Rate	[Setting method] Enter a value manually. [Default value] 0.95

Parameter	Description	Setting
Distance(M)	The distance between camera and target.	[Setting method] Enter a value manually. [Default value] 15  NOTE Enter actual distance when the distance between camera and target is less than 15m. Enter 15 when the distance between camera and target is great than or equal to 15m.
Alarm	Open or close the alarm output and linkage of area.	[Setting method] Tick the alarm areas

Step 3 Set temperature area.

Step 1. Tick an area ID.

Step 2. Select type from drop-list.

Step 3. Press and hold the left mouse button, and drag in the video area to draw a temperature area, as shown in Figure 5-5. Right-click to finish the area selected.

Figure 5-5 Temperature Area Setting Interface

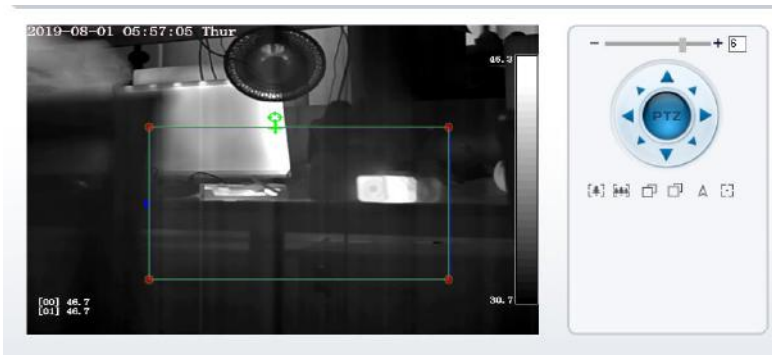

Step 4. Click **Apply**, the message “Apply success” is displayed, the temperature area is set successfully.

Delete a temperature area:

Step 1. Select an area ID.

Step 2. Click the temperature area and right-click.

Step 3. Remove the tick of area ID.

Step 4. Click **Apply**, the message “Apply success” is displayed, the temperature area is deleted successfully.

Step 4 Click **Apply**.

The message "Apply success" is displayed, the system saves the settings.

----End

5.3 Shield Area

Shield area is meaning that the camera will not to detect the temperature of that area.

Operation Procedure

Step 1 Choose **Configuration >Thermal > Shield Area**.

Figure 5-6 Shield Area

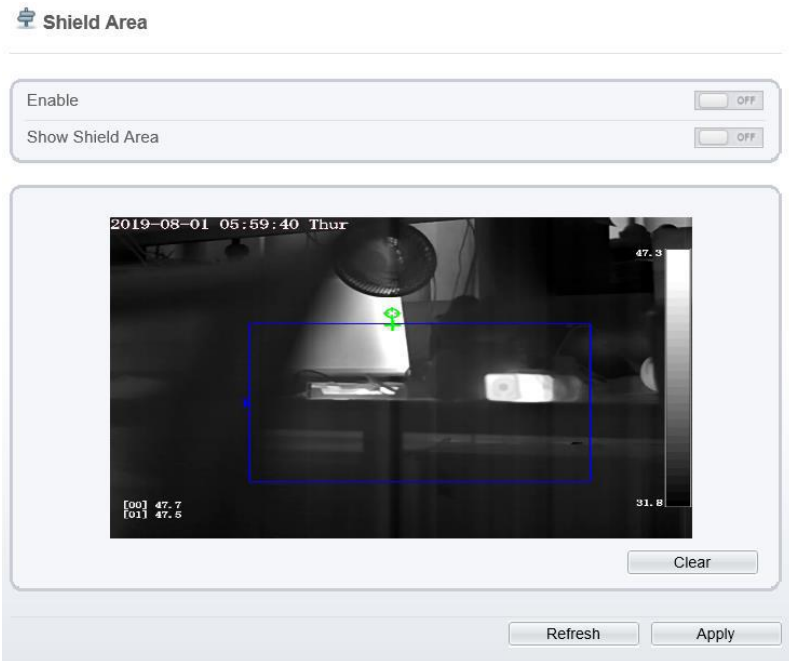

Step 2 Enable the shield area.

Step 3 Enable **Show Shield Area**, then the setting shield will show on live video.

Step 4 Click left mouse button to set area, click right mouse button to end the setting.

Step 5 Click **Clear** to clear the shield area.

----End

5.4 Schedule Linkage

Operation Procedure

Step 1 Choose **Configuration > Thermal > Schedule Linkage**.

The **Schedule Linkage** page is displayed, as shown in Figure 5-7. There are two channels alarm output. It can also enable alarm record, SMTP and FTP upload.

Figure 5-7 Schedule Linkage

Step 2 Tick the output channel.

Step 3 Set schedule linkage.

Method 1: Click left mouse button to select any time point within 0:00-24:00 from Monday to Sunday as shown in Figure 5-7.

Method 2: Hold down the left mouse button, drag and release mouse to select the alarm time within 0:00-24:00 from Sunday to Saturday.

NOTE

When you select time by dragging the cursor, the cursor cannot be moved out of the time area. Otherwise, no time can be selected.

Method 3: Click  in the alarm time page to select the whole day or whole week.

Deleting alarm time: Click  again or inverse selection to delete the selected alarm time.

Step 4 Click **Apply**.

The message "Apply success" is displayed, the system saves the settings.

Step 5 There are five types schedule linkage to set, like threshold alarm, threshold warning, temperature difference alarm, temperature difference warning and temperature section alarm.

----**End**

5.5 Bad Point Check

Operation Procedure

Step 1 Choose **Configuration > Thermal > Bad Point Check**.

The **Bad Point Check** page is displayed, as shown in Figure 5-8.

If the image is defect by detector's fault, user can test the function to recover the bad point. User should connect the manufactory at this condition to make sure to apply.

Figure 5-8 Bad Point Check

**Step 2** Click the white point at image, click **Apply** to recover the bad point, as shown in Figure 5-9

Figure 5-9 Recover bad point



Step 3 Click **Reset** to return the previous settings.

Step 4 Click **Apply**. The message "Apply success" is displayed, the system saves the settings.

----End

5.6 Version Information

Choose **Configuration > Thermal > Version Information**. User can view the version information as shown in Figure 5-10.

Figure 5-10 Version Information

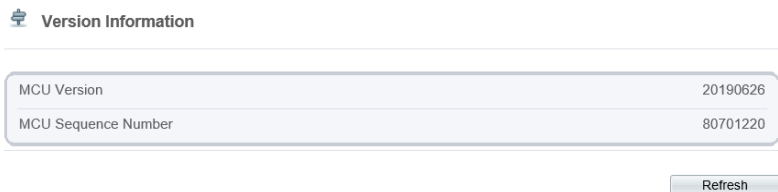

----End

6 Parameter Setting

6.1 Sensor Setting Interface

Operation Procedure

Step 1 On the Internet Explorer interface or the client software interface, select and right-click the surveillance image to the set, as shown in Figure 6-1.

Figure 6-1 Sensor Setting

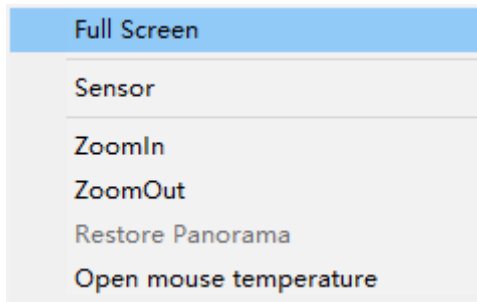

Table 6-1 Right-click setting parameters

Parameter	Description	Setting
Full screen	Click it, the live video will display in full screen	[Setting method] Click
Sensor	Set parameters of sensor, more details please refer next chapters.	[Setting method] Click
Zoom In/ Zoom Out	N/A	[Setting method] Click
Open mouse temperature	Click this, and mouse cursor display temperature of point that cursor's position.	[Setting method] Click

Step 2 Choose **Sensor**. The **Sensor Configuration** dialog box is displayed, as shown in Figure 6-2.

----End

6.2 Time Segment

Figure 6-2 shows the time segment interface.

Figure 6-2 Time segment interface

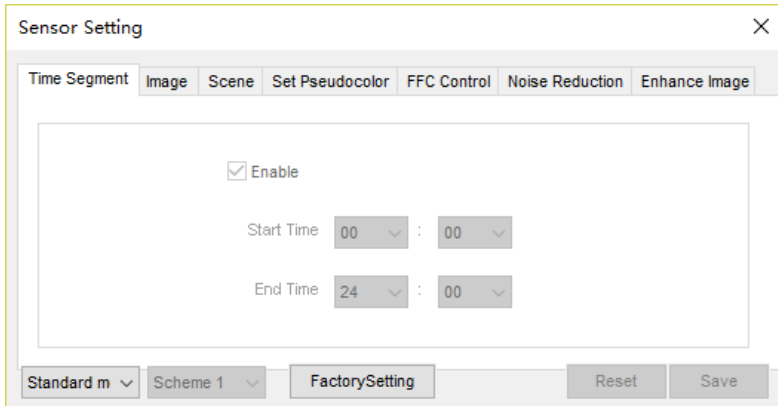

Operation Procedure

- Step 1 Click **Standard** in the lower left corner of Sensor Setting, and choose **Debug Mode**.
- Step 2 Tick **Enable**.
- Step 3 Set the **Start Time**
- Step 4 Set the **End Time**
- Step 5 Click **Save**, the message "Save succeed" is displayed, the system saves the settings.

----End

6.3 Image Setting

Figure 6-3 shows the image setting interface.

Figure 6-3 Image interface

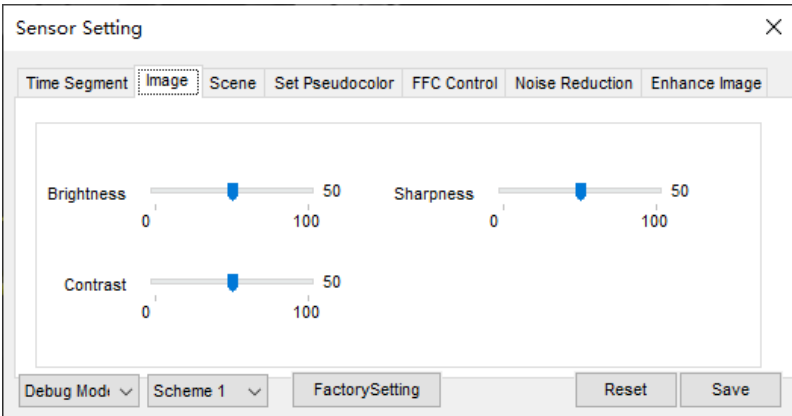

Table 6-2 lists the image setting parameters.

Table 6-2 Image setting parameters

Parameter	Description	Setting
Sharpness	Sharpness indicates the sharpness of the image plane and the sharpness of the image edge. The shaper the image, the better detail contrast.	[Setting method] Drag the slider. [Default value] 50
Brightness	It indicates the total brightness of an image. As the value increases, the image becomes brighter.	[Setting method] Drag the slider. [Default value] 50
Contrast	It indicates the contrast between the bright part and the dark part of an image. As the value increases, the contrast increases.	[Setting method] Drag the slider. [Default value] 50

----End

6.4 Scene

Figure 6-4 shows the scene interface.

Figure 6-4 Scene interface

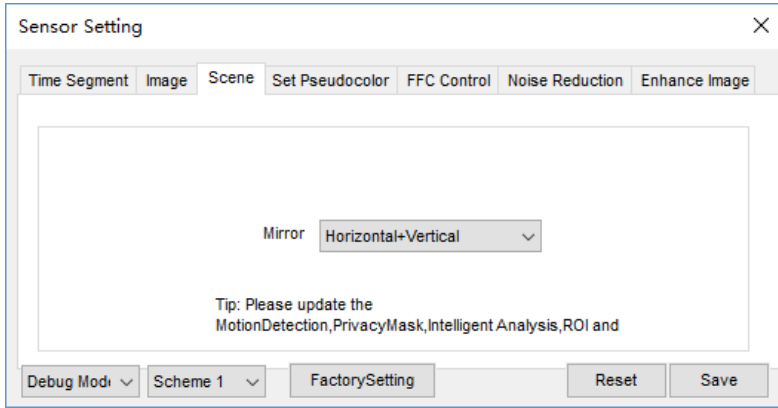

Provide the selection of image pixel locations.

Normal: the image is not flipped.

Horizontal: the image is flipped left and right.

Vertical: the image is flipped up and down.

Horizontal + Vertical: the image upside-down and reversal.

6.5 Pseudocolor

Figure 6-5 shows the set pseudocolor interface.

Figure 6-5 Set pseudocolor interface

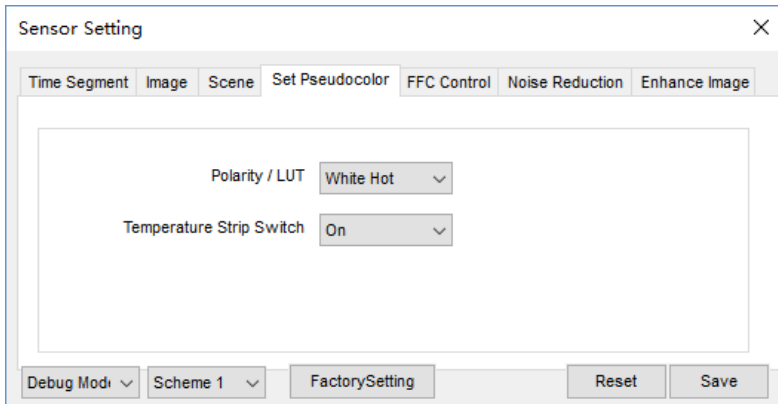

Polarity/LUT: the temperatures of the temperature fields detected by the thermal imaging camera are separately mapped to values ranging from 0 to 255 by the algorithm. In the black/white display mode, this range is converted to the grayscale tones. For example, 0 indicates completely black, and 255 indicates completely white.

The temperature field of the scene is converted to images by using the grayscale ranging from 0 to 255. Different polarity modes can be converted to different display images. The most common setting is white hot (a hotter object is displayed brighter than a colder object) or black hot (a hotter object is displayed darker than a colder object). The difference between two modes lies in that the temperatures corresponding to the darker one and the lighter one are reversed. Other modes include rainbow, ironbow, HSV, autumn, bone and so on.

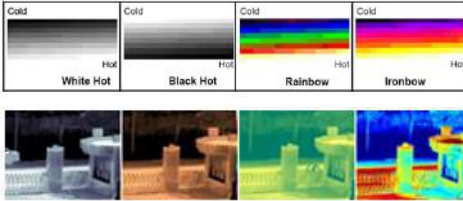

Temperature strip switch is on, the live video will show it, otherwise is no strip.

6.6 FFC Control

Figure 6-6 shows the FFC control interface.

Figure 6-6 FFC control interface

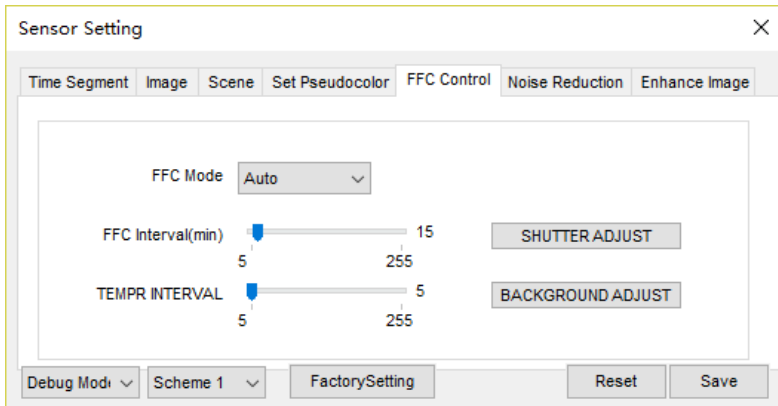

Table 6-3 lists the parameters on the FFC control interface.

Table 6-3 Parameters on the FFC control interface

Parameter	Description	Setting
FFC Mode	The internal of the thermal imaging camera may comprise the mechanical action correction mechanism that can periodically improve the image quality. This component is called flat field correction (FFC). When controlling the FFC, the	[How to set] Select from the drop-down list box.

Parameter Setting

Parameter	Description	Setting
	<p>FFC shields the sensor array, so that each portion of the sensor can collect uniform temperature fields (flat field). By means of FFC, the camera can update the correction coefficients to output more uniform images. Throughout the FFC process, the video image is frozen for two seconds and a static-frame image is displayed. After the FFC is complete, the image is automatically recovered. Repeated FFC operations can prevent the grainy and image degradation problems. The FFC is especially important when the temperature of the camera changes. For example, after the camera is powered on or the ambient temperature is changed, you should immediately perform the FFC.</p> <p>Auto: In the Automatic FFC mode, the camera performs FFC whenever its temperature changes by a specified amount or at the end of a specified period of time (whichever comes first). When this mode is selected, the FFC interval (minutes) ranges from 5 to 30 minutes. The temperature change of the camera is based on the temperatures collected by the internal temperature probe. The temperature of the camera sharply changes when the camera is powered on. The FFC is relatively frequent, which is normal.</p> <p>Manual: In the manual FFC mode, the camera does not automatically perform the FFC based on the temperature change or the specified period. You can press the Do FFC button to select the manual FFC mode. When you feel that the image is obviously degraded but the automatic FFC is not performed, you can use the manual FFC function to check whether the image quality can be improved.</p>	<p>[Default value] Auto</p>
FFC Interval (min)	In the automatic FFC mode, the FFC interval ranges from 5 to 255 minutes.	<p>[How to set] Drag the slider. [Default value] 5</p>
Temper Interval	In the automatic FFC mode, the FFC interval ranges from 5 to 25.5 centigrade.	<p>[How to set] Drag the slider. [Default value] 5</p>

Parameter	Description	Setting
Shutter Adjust	Click the icon to adjust exposure immediately.	[How to set] Click
Background Adjust	Click the icon and cover the camera with something to adjust image. Remove the thing to finish adjustment.	[How to set] Click

----End

6.7 Noise Reduction

Figure 6-7 shows the Noise reduction interface.

Figure 6-7 Noise reduction interface

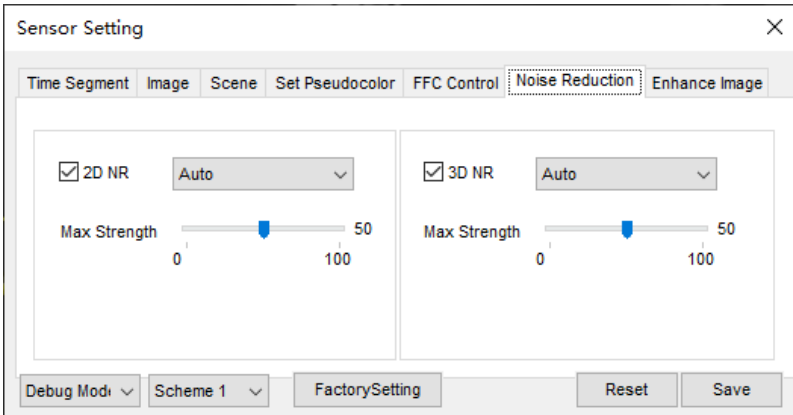

Table 6-4 lists the Noise reduction parameters.

Table 6-4 Parameters on the Noise reduction interface

Parameter	Description	Setting
2 DNR	Decrease the image noise.	[How to set] Tick Select from the drop-down list box. [Default value] Auto
Max Strength	At auto mode, user can adjust the value.	[Setting method] Drag the slider. [Default value] 50
3 DNR	Decrease the image	[How to set]

Parameter	Description	Setting
	noise. Manual mode: drag the slider to adjust fixed strength.	Tick [How to set] Select from the drop-down list box.
Fixed Strength	At manual mode, user can adjust the value.	[Setting method] Drag the slider. [Default value] 50

----End

6.8 Enhance Image

Figure 6-8 shows the **Enhance Image** interface.

Figure 6-8 Enhance image interface

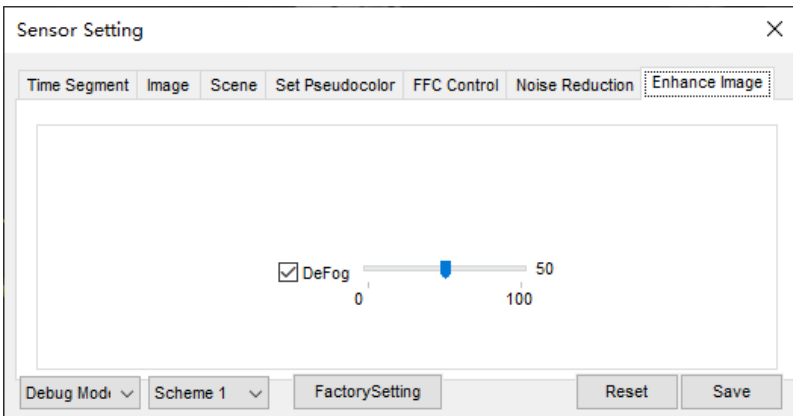

Defog: tick to enable , and drag the slider to adjust. The default value is 50.

----End

7 Technical Specifications

Table 7-1 lists the specifications of the thermal imaging box camera.

Table 7-1 Technical specifications

Type	Parameter	Description
Detector performance	Detector type	Uncooled infrared focal plane sensor
	Sensing mode	Micro bolometer
	Pixel	800x600
	Pixel spacing	17 um
	Response waveband	8-14 um
	Thermal sensitivity NETD	No more than 40mK
	Frame frequency	50/60 Hz
Lens features	Prime lens	8/15/25/35/50mm (optional)
	Focusing mode	Manual
	F value	1.0
	Recognition distance (Human body)	59/110/184/257/368 meters
	Recognition distance (Vehicle)	180/338/564/789/1127 meters
	Zoom lens	8/25/50/75 (optional)
	Focusing mode	Auto
	F value	1.0
	Recognition distance (Human body)	59/184/368/551/735 meters
	Recognition distance (Vehicle)	180/564/1127/1691/2255 meters
	Imaging features	Polarity LUT
DNR		2D/3D

Technical Specifications

Type	Parameter	Description
	Contrast	Support
	Mirror	Horizontal, Vertical, Horizontal + Vertical
	OSD display	Support
Video features	Video encode format	H.264/ H.265/MJPEG
	Video resolution/frame rate	Stream 1: D1/800x600/1024x768 50/60fps Stream 2: CIF 25/30 fps CIF 50/60fps
	Multiple code streams	Two base streams and one SVC stream
	Image setting	Brightness, contrast, sharpness
	Bit rate format	CBR/VBR
	Synchronous mode	Inter-sync
	SNR	55 dB
	DNR	Automatically /manually, Support 3 D noise reduction
Audio features	Audio encode format	G.711: 8 kbps; RAW_PCM: 16 kbps
Thermal performance	Temperature Measurement Function	Point temperature measurement, Regional temperature measuring, Full screen temperature measurement (the highest temperature, the lowest temperature and the average temperature)
	Alarm Temperature Detection	Over temperature alarm, temperature difference alarm, temperature change trend alarm (platform software function)
	Temperature Measurement accuracy	$\pm 2^{\circ}\text{C}$ or $\pm 2\%$, the higher one (it depends emissivity, distance, temperature, etc.)
	Multiple temperature area	Support.
	Temperature response time	Less than 30 millisecond

Type	Parameter	Description
	Temperature range	-40°C ~ +150°C
	Display thermometry mode	If the object's temperature is more than 5°C, it will be shown absolute temperature. If the object's temperature is less than or equal to 5°C, it will be shown relative temperature(DEV= maximum-average)
Coding features	Multiple code streams	Support
	Bit rate control	CBR/VBR
Network features	Network protocol	IPv4/IPv6, RTSP/RTP/RTCP, TCP/UDP, HTTP, DHCP, DNS, FTP, DDNS, PPPOE, SMTP, and SIP
	Heartbeat mechanism	Support
	Stream mode	Unicast
	Maximum user access amount	10 users
	ONVIF	Support
	Automatic device discovery	Support
	WEB management	Embedded WEB service, remote browsing and configuration over IE browser.
	Remote upgrade and maintenance	Support
	Maximum user access amount	Simultaneous access of 10 users to the maximum.
Interface features	Network interface	RJ-45 and 10/100Base-T
	Audio interface	1-channel audio input and 1-channel audio output, supporting bidirectional voice talkback.
	Alarm interface	2-channel alarm input and 2-channel alarm output.
	Analog video output interface	BNC, 75 Ohm

Technical Specifications

Type	Parameter	Description
	Pan & tilt control interface	RS 485
	SD card connector	Micro SD card/HCS D card, 128 GB to the maximum.
	Reset	Support
	Power interface	Support DC 12V
System function features	Intelligent alarm	Motion detection alarm, I/O alarm, disk alarm, intelligent analysis alarm, temperature measurement alarm.
	ROI	Support
	Time segment	Support
	IO alarm detection	Support
	Privacy mask	Support
	Storage	Local storage, NAS storage, and SD card storage
	Character display	Time, date, device name and user-defined characters
	Security	Password protection, multi-level user group management, user-define permissions, and one-key reset
	Reliability	Provide software and hardware watchdogs and automatic fault recovery
	user authority	Two class, administrator and general users. The administrator can assign various permissions to general users
	Support SDK development	Linux C /windows C & C++ SDK
Web application	Language	Support 10 languages, English, Chinese, Russian, French, Spanish, Portuguese, Polish, Czech, Hungarian, Italian
	Support browsers	Windows IE 8 or later version, Firefox, Chrome
	Manager and maintenance	Support Web upgrade, video browsing, cloud control, parameter configuration, etc.

Type	Parameter	Description
	Web interface style	Customization/standard
Physical features	Power supply	DC 12 V
	Power consumption	5 W
	Operating temperature	-40°C to +60°C
	Operating humidity	RH 90% MAX (no condensation)
	Installation mode	1/4" 20 UNC mount block (install top or bottom of camera)
	Dimensions	72*70*189 mm(50 mm lens)
	Weight	About 700 g (50 mm lens)

A Troubleshooting

Common Trouble	Possible Cause	Solution
Unable to access the web	Network is not connected.	<ul style="list-style-type: none"> • Connect the network cable of the camera to the PC to check whether the network cable is in good contact. • Run the ping command to check the network connection and whether the device works normally.
	IP address is occupied.	Directly connect the camera to the PC, and reset the IP address of the camera.
	The IP addresses of the PC and the device are in different networks.	Check the IP address, subnet mask and gateway setting of the camera.
PTZ or high speed dome is out of control.	The protocol, bit-rate, or address setting of the PTZ is incorrect.	Modify the address of the PTZ on the web.
	The signal cable is unconnected or not connected correctly.	Check the signal strength, and reconnect the signal cable.
The measured temperature is not accurate.	The device is just powered on, and the temperature of the cavity is unstable.	The temperature of the cavity is stable within 15 to 30 min after the device is powered on.
	The FFC mode is incorrect.	The FFC mode is auto by default. If the mode is set to manual, it will be no block calibration, which may lead to fuzzy pictures and inaccurate temperature.
	The target configuration is incorrect.	Check whether the emission rate and distance of the target are configured correctly.

Common Trouble	Possible Cause	Solution
An error occurs in accessing the web of the device after the upgrade.	The data in the cache of browser is not updated in time.	<p>Delete the cache of the Internet Explorer. The steps are as follows (taking IE9 as an example):</p> <ol style="list-style-type: none"> 1. Open the Internet Explorer. 2. Select Tools > Internet Options. 3. On the General tab, select Delete under Browsing history. The Delete Browsing History dialog box appears. 4. Select all check boxes. 5. Click Delete. <p>Login again the web page of the camera.</p>
Upgrade failed.	<ul style="list-style-type: none"> • No network cable is connected. • The network setting is incorrect. 	<ul style="list-style-type: none"> • Ensure the upgrade network is connected. • Check whether the network setting is correct.
	The upgrade package is incorrect.	Perform the correct upgrade package again.

B Common Emission Rate

Emission Rate

The emission rate is the capability of an object to emit or absorb energy. An ideal transmitter provides an emission rate of emitting 100% of intake energy. An object with an emission rate of 0.8 can absorb 80% of intake energy, and reflect the remaining 20%. The emission rate is the ratio of the energy emitted by an object at a specific temperature to that emitted by an ideal radiator at the same temperature. The range of emission rate value is 0.0 to 1.0 generally.

Materials	Temperature (°C/°F)	Emissivity
Gold (High-purity)	227/440	0.02
Aluminum foil	27/81	0.04
Aluminum sheet	27/81	0.18
Aluminum used for families (flat)	23/73	0.01
Aluminum plate (98.3% purity)	227/440	0.04
	577 10	0.06
Aluminum plate (rough)	26/78	0.06
Aluminum (oxidized @ 599°C)	199/390	0.11
	599/1110	0.19
Polished aluminum	38/100	0.22
Tin (light tinned Iron sheet)	25/77	0.04

Nickel wire	187/368	0.1
Lead (99.9% purity, No oxidized)	127/260	0.06
Copper	99 90	0.18
Cobalt	599/111	0.19
Steel	199/390	0.52
	599/1110	0.57
Tinned iron sheet (Light)	28/82	0.23
Brass(High-polish)	247/476	0.03
Brass (Tough rolled, polished metal wire)	21/70	0.04
Tinned Iron (Light)	-	0.13
Iron plate (Rust eaten)	20/68	0.69
Rolled steel sheet	21/71	0.66
Ferric oxide	100/212	0.74
Wrought-iron	21/70	0.94
Fused iron	1299-1399/3270-2550	0.29
Copper (Polished)	21-117/70-242	0.02
Copper(Polished, not reflected)	22/72	0.07
Copper (Heavy oxide Board)	25/77	0.78
Enamel (Fuse on iron)	19/66	0.9
Formica Plate	27/81	0.94

Frozen soil	-	0.93
Brick (Red, rough)	21/70	0.93
Brick (Unglazed, rough)	1000/1832	0.8
Carbon (T - carbon 0.9% ash)	127/260	0.81
Concrete	-	0.94
Glass (Glossy)	22/72	0.94
Granite (Surfaced)	21/70	0.85
Ice	0/32	0.97
Marble (I Polished, grey)	22/72	0.93
Asbestos board	23/74	0.96
Asbestos paper	38/100	0.93
	371/700	0.95
Asphalt (Paving the road)	4/39	0.97
Paper (Black tar)	-	0.93
Paper (White)	-	0.95
Plastic (White)	-	0.91
plywood	19/66	0.96
Water	-	0.95
Wood (Fresh scent)	-	0.9

101-200-0143-01